

# ICARO

Pareti doccia

Shower cabins

Duschkabinen

Parois de douche

 Arblu®



## **\_IT Legenda \_EN Legend \_DE Symbolenbezeichnung \_FR Legende**

**ANG** Angolo / Corner / Ecke / Angle

**NIC** Nicchia / Niche / Nische / Niche

**Q** Quadrato / Squared / Quadratisch / Carré

**R** Rettangolare / Rectangular / Rechteckig / Rectangulaire

**1AB** 1 Anta Battente / 1 Wing door / 1 Schwenktür / 1 Porte battante

**2AB** 1 Ante Battenti / 2 Wing doors / 2 Schwenktüren / 2 Portes battantes

**2SL** 2 Ante Saloon / 2 Saloon Doors / 2 Pendeltüren / 2 Portes Saloon

**1LF** 1 Lato Fisso / 1 Fixed Side / 1 Fixteil / 1 Côté Fixe

**1LA** 1 Lato Aggiuntivo / 1 Additional Side / 1 Zusatzseite / 1 Côté Additionnel

 Video tutorial / Tutorial video / Online-Anleitungen / Tutoriel vidéo

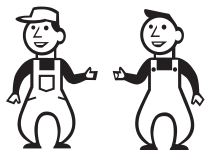

EST>1100mm

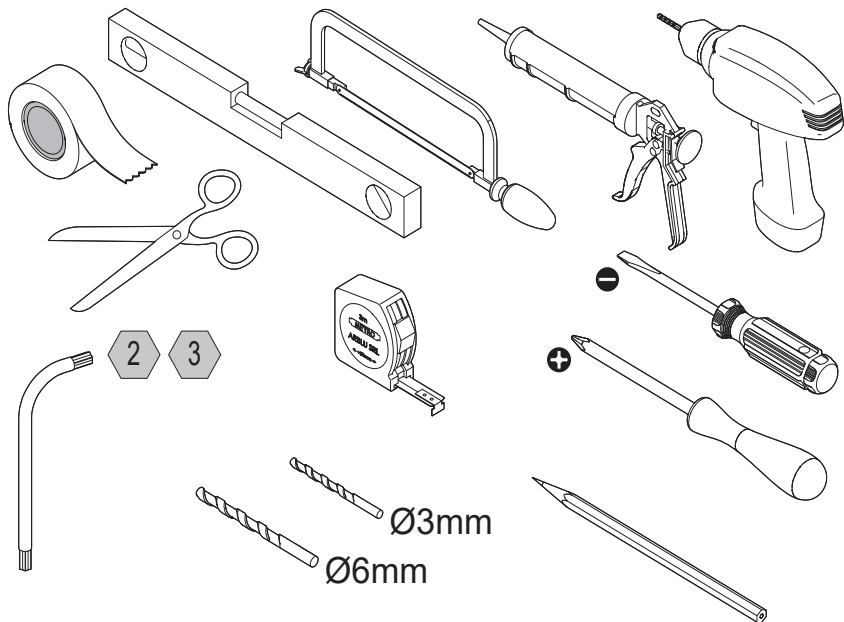

**VERIFICARE LA BOLLA**  
**VERIFY THE FLATNESS**  
**DIE WAAGRECHTIGHEIT KONTROLLIEREN**  
**VÉRIFIER LE FIL À PLOMB**

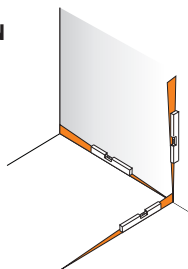

UNI 11809

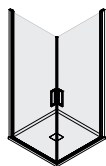

ANG Q-R 2AB



---

→ 9

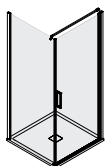

ANG Q-R 1AB+1LF



---

→ 12

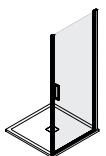

NIC 1AB



---

→ 16

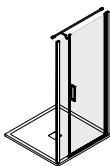

NIC 1AB+1LF



---

→ 20



NIC 2SL



→ 24

---

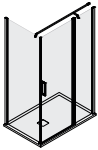

ANG Q-R 1AB+1LF

**PLUS**



→ 27

---

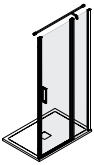

NIC 1AB

**PLUS**



→ 31

---

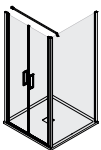

1 LA



→ 36

---

## IT SCHEDA PRODOTTO

## CARATTERISTICHE PRINCIPALI DEL MATERIALE:

**PULIBILITÀ:** le superfici dei componenti delle pareti doccia che sono accessibili durante l'utilizzo e la pulizia sono prive di spigoli vivi, bordi e bave; l'utilizzo dei detersivi raccomandati dalla ditta costruttrice non alterano la sicurezza e/o funzionamento della parete doccia.

**RESISTENZA AGLI URTI/PROPRIETÀ DI FRAMMENTAZIONE:** i vetri utilizzati sono temprati termicamente e soddisfanno i requisiti delle norme EN 12150-1 e EN 14428; le lastre in cilex sono materiali in polistirene e conformi alla norma EN 14428.

**DURABILITÀ:** le pareti doccia sono durevoli in quanto conformi ai seguenti requisiti:

- Pulibilità
- Resistenza agli urti/proprietà di frammentazione
- Resistenza alla corrosione / Resistenza agli agenti chimici e alle macchie
- Resistenza a fatica / Resistenza ai cicli di bagnatura e asciugatura
- Stabilità
- Retenzione dell'acqua

## QUALITÀ CERTIFICATE DEI PROFILI IN ALLUMINIO SECONDO I MARCHI EUROPEI:

• QUALANOD per il processo di ossidazione / QUALICOAT per il processo di verniciatura

**MATERIALI POTENZIALMENTE ALLERGENICI:** dove presenti queste sostanze sono opportunamente rivestite in modo da evitare il contatto.

- MANIGLIE: in zama finitura cromata o verniciata in alluminio finitura cromata o verniciata in ABS in finitura cromata o verniciata
- BRACCETTI: alluminio finitura ossidata o verniciata
- CERNIERE, COMPONENTI, VITERIA: cerniere in zama finitura cromata o verniciata componenti plastici in ABS, PA, PA6, PA66, PTFE, PTE con finitura da stampo, cromata o verniciata
- COMPONENTI in zama con finitura da stampo, nichelata, cromata o verniciata viti in acciaio inox A2 o A4
- GUARNIZIONI: in PVC o TPE.

## INFORMAZIONI GENERALI:

Prima di installare e allegare la parete doccia si prega di leggere attentamente la presente scheda e le istruzioni di montaggio integrate al prodotto, da conservare per successive consultazioni. Prima di installare la parete doccia assicurarsi che:

1. L'installazione sia effettuata da personale qualificato;
2. L'alimentazione idraulica sia staccata;
3. L'impianto idraulico sia costruito secondo la regola dell'arte prevista dalla normativa vigente in materia;
4. La predisposizione idraulica sia conforme alla tipologia di prodotto da installare;
5. Il locale di posizionamento della parete doccia sia idoneo per la tipologia di prodotto da installare;
6. La parete sulla quale viene effettuata l'installazione sia adatta a tale scopo, prestare attenzione alle pareti in cartongesso altri e materiali che non siano stati adeguatamente attrezzati;
7. Il contenuto dell'imballo sia conforme a quanto ordinato;
8. Gli articoli non siano danneggiati.

## AVVERTENZE DI SICUREZZA:

I prodotti Arblu sono costruiti nel rispetto delle norme di sicurezza vigenti, è necessario, pertanto, seguire le seguenti avvertenze al fine di una corretta installazione e un corretto utilizzo del prodotto:

1. Assicurarsi che i tasselli forniti nel kit ferramenta siano idonei al tipo di muro, in caso contrario utilizzare di adeguati;
2. Si raccomanda particolare attenzione durante la movimentazione dei cristalli nella fase di montaggio, specialmente per le pareti doccia senza profili, salvaguardando gli spigoli che, se sollecitati, potrebbero far sbilanciare il cristallo;
3. La parete doccia deve essere utilizzata da persone con adeguate conoscenze sul suo utilizzo in sicurezza, il prodotto non è adatto all'uso da parte dei bambini e dalle persone portatori di handicap senza adeguata sorveglianza;
4. Non appendersi alle maniglie e ai braccetti;
5. Non applicare al vetro nessun accessorio se non predisposto dalla ditta costruttrice

## ISTRUZIONI PER LA CURA E MANUTENZIONE:

Vetri: per consentire una facile pulizia, i cristalli, che non si sovrappongono ad anta chiusa, sono stati dotati di guarnizioni trasparenti ed antimuffa, facilmente sfilabili e infilabili. Arblu propone un apposito kit pulizia che impedisce all'acqua di fermarsi in superficie; è comunque possibile utilizzare un panno morbido e detersivi neutri specifici per il vetro. Si consiglia sempre di asciugare i vetri e i profili in alluminio ad ogni fine utilizzo. Importante non usare salviette abrasive, detersivi in polvere, acetone, detersivi abrasivi e aggressivi. Per vetri trattati con SGP è sconsigliato l'uso di panni in microfibra.

## GARANZIA:

I prodotti saranno idonei all'uso al quale vengono normalmente destinati e saranno garantiti da non conformità e difetti di materiale e lavorazione. In ogni caso, misure, tinte, colori, illustrazioni e disegni di cataloghi e/o campionari saranno meramente indicativi. La garanzia comporta unicamente la sostituzione dei prodotti e/o delle parti da noi riconosciuti difettosi. Sono esclusi dalla garanzia e da ogni responsabilità di Arblu Srl i fenomeni degradati e l'usura dei Prodotti, come pure ogni difetto o mancanza di qualità dovuti od influenzati da immagazzinaggio, conservazione errati. La garanzia non opererà qualora i Prodotti abbiano subito qualsiasi tipo di modifica da parte dell'Acquirente e/o di terzi, e/o che risultino essere manomessi, installati e/o utilizzati non conformemente alle condizioni di impiego previste dalla documentazione consegnata con il prodotto. In nessun caso si darà luogo ad intervento in garanzia decorsi 24 (ventiquattro) mesi dalla consegna.

## SALVAGUARDIA AMBIENTALE:

Il prodotto e i componenti dello stesso, compresi gli imballi, non devono essere dispersi nell'ambiente ma smaltiti come da normativa ambientale vigente.

L'originale del presente documento è redatto in lingua italiana, pertanto ogni traduzione deve essere conforme a quanto previsto nella lingua originaria del presente.

La presente dichiarazione e la DOP sono disponibili nel sito [www.arblu.com](http://www.arblu.com)

## EN PRODUCT DETAILS

## MAIN CHARACTERISTICS OF THE MATERIALS:

**CLEANABILITY:** the surfaces of shower wall components that are accessible during the use and cleaning do not have sharp edges, corners and featherheads; the use of detergents recommended by the manufacturing company do not alter the safety and/or functioning of the shower cabins.

**SHOCK RESISTANCE/FRAGMENTATION PROPERTY:** the glass used is thermally toughened and satisfies the requisites of regulations EN 12150-1 and EN 14428; the cilex slabs are made from polystyrene materials and comply with regulation EN 14428.

**DURABILITY:** the shower walls are durable as they comply with the following requisites:

- Cleanability
- Shock resistance/fragmentation property
- Corrosion resistance / Resistance to chemical agents and stains
- Fatigue resistance / Resistance to wetting and drying cycles
- Stability
- Water retention

## CERTIFIED QUALITY OF ALUMINIUM PROFILES ACCORDING TO EUROPEAN BRANDS:

• QUALANOD for the oxidation process / QUALICOAT for the varnishing process

**POTENTIAL ALLERGENIC MATERIALS:** these substances are adequately coated in order to avoid contact.

- HANDLES: in zama chromed or varnished in aluminium chromed or varnished in ABS chromed or varnished
- SUPPORT ARMS: aluminium oxidized or varnished
- HINGES, COMPONENTS, SCREWS: hinges in zama chromed or varnished moulded plastic components in ABS, PA, PA6, PA66, PTFE, PTE, chromed or varnished moulded components in zama, nichel-plated, chromed or varnished inox steel screws A2 or A4
- GASKETS: in PVC or TPE

## GENERAL INFORMATION:

Before installing and using the shower cabin we ask you to carefully read this product information sheet and the assembly instructions attached to the product. Keep these instructions for further information. Before installing the shower make sure that:

1. The installation is carried out by qualified personnel;
2. The hydraulic infread is detached;
3. The hydraulic system is built to standard and according to the current regulations;
4. The hydraulic preparation complies with the type of product to be installed;
5. The place where the shower is to be placed must be suitable to the type of product to be installed.
6. The walls on which the installation is to be carried out must be suitable for this purpose, be careful if these walls are made from plasterboard and other materials that have not been adequately equipped;
7. The contents of the package comply with the order;
8. The articles are not damaged.

## SAFETY WARNINGS:

The Arblu products are manufactured in compliance with current safety norms and thus it is necessary to comply with the following instructions for a correct installation and correct use of the product:

1. Make sure that the dowels supplied in the hardware kit are suitable to the type of wall. If these are not suitable to the type of wall use other adequate dowels;
2. We recommend that you pay special attention when handling the glass during assembly and especially when installing shower stalls without profiles. Protect the edges as these could break the glass if stressed;
3. The shower cabin must be used by people with adequate knowledge on how to use it in a safe way. The product should not be used by children without supervision and/or by people with disabilities;
4. Do not hang from the handles or arms.
5. Do not apply any accessories to the glass if not provided by the manufacturing company

## INSTRUCTIONS FOR CARE AND MAINTENANCE:

Glass: for easy cleaning of the glass that do not overlap with the door closed, there are transparent and mold-proof seals that are easily removable and to insert. Arblu offers a cleaning kit that avoids water from staying on the surface; however you can use a soft cloth and neutral detergents on the glass. We recommend that the glass and aluminium edges be dried after each use. Do not use abrasive cloths, washing powders, acetone and/or abrasive and harsh detergents. For glass treated with SGP the use of microfibre cloths is not recommended.

## WARRANTY:

The products will be suitable for the use they are normally intended for and will be guaranteed by non-conformity and defects in material and workmanship. In any case, measurements, tints, colours, illustrations and drawings on catalogues and/or samples will be merely indicative. The warranty only covers the replacement of products and parts which we acknowledge as being defective. The normal degradation and wear of the products, as well as any defect or lack of quality due or influenced by incorrect storage, are excluded from the warranty and liability of Arblu srl. The warranty does not cover damage to products that have been tampered with by the Buyer and / or third parts, installed and / or used not in accordance with the operating conditions supplied with the product. Under no circumstances a warranty intervention will take place once elapsed 24 months from delivery date.

## ENVIRONMENTAL PROTECTION:

The product and its components, including packaging, must not be dispersed in the environment but disposed of in accordance with current environmental legislation.

In case there are doubts or difficulties to understand this technical instructions, take into consideration the original version, prepared in Italian.

This declaration and the DOP are available in our website [www.arblu.com](http://www.arblu.com)

## DE PRODUKTKARTE

## HAUPTMERKMALE DER MATERIALIEN:

**REINIGUNGSFÄHIGKEIT:** die Oberflächen der Duschkabinkomponenten, die während des Gebrauchs und der Reinigung zugänglich sind, weisen weder scharfe Kanten, Ränder noch Grat auf. Die Verwendung der vom Hersteller empfohlenen Reinigungsmittel verändern in keiner Weise die Sicherheit und/oder Funktion der Duschkabine.

**Schlagfestigkeit/Splittereigenschaft:** die verwendeten Glasscheiben bestehen aus thermisch gehärtetem Glas und entsprechen den Anforderungen der Normen EN 12150-1 und EN 14428. Die Crillexplatten sind aus einem Polystyrolmaterial und entsprechen der Norm EN 14428.

**HALTBARKEIT:** die Duschkabine sind dauerhaft, da sie den folgenden Anforderungen entsprechen:

- Reinigungsfähigkeit
- Schlagfestigkeit/Splittereigenschaft
- Korrosionsfestigkeit / Resistent gegen Chemikalien und fleckenabweisend
- Dauerfestigkeit / Resistent gegen Nässe und Trocknung
- Stabilität
- Wasserrückhalt

**MIT DEN EUROPÄISCHEN MARKENZEICHEN BESCHIEINIGTE QUALITÄT DER ALUMINIUMPROFILE:**

- QUALANOD für den Oxidationsablauf / QUALICOAT für die Lackierung

**POTENTIELL ALLERGENE STOFFEN:** wo diese Substanzen vorhanden sind, werden sie zur Vermeidung jedes Kontaktes entsprechend beschichtet.

- **GRIFFE:** aus Zamak, verchromt oder lackiert  
aus Aluminium, verchromt oder lackiert  
aus ABS, verchromt oder lackiert
- **HALTERUNGEN:** aus Aluminium, oxidiert oder lackiert
- **SCHARNIERE, BESTANDTEILE, SCHRAUBEN:** Scharniere aus Zamak, verchromt oder lackiert  
Bestandteile aus ABS, PA, PA6, PA66, PTFE, PTE in Gussformausführung, verchromt oder lackiert  
Bestandteile aus Zamak in Gussformausführung, vernickelt, verchromt oder lackiert  
Schrauben aus Edelstahl A2 oder A4
- **DICHTUNGSLEISTEN:** aus PVC oder TPE

## ALLGEMEINE HINWEISE:

Vor der Installation und Benutzung der Duschkabine bitte die Produktkarte und die dem Produkte beiliegenden Montageanleitungen aufmerksam lesen und für ein späteres Nachlesen aufbewahren. Vor der Installation der Duschkabine sicher stellen, dass:

1. Die Installation durch qualifizierte Fachleute erfolgt.
2. Die Wasserversorgung abgetrennt wurde.
3. Die Wasseranlage sachgerecht nach den diesbezüglich vorgesehenen Bestimmungen eingebaut wurde.
4. Die hydraulische Vorrichtung der Art des zu installierenden Produkts entspricht.
5. Der Aufstellungsort der Duschkabine sich für die Art des zu installierenden Produkts eignet.
6. Die Wand an der die Installation erfolgt, muss sich für dieselbe eignen, besonders auf Wände mit Regipplatten und andere Stoffen achten, die nicht entsprechend vorgerüstet sind.
7. Der Verpackungsinhalt muss mit der Bestellung übereinstimmen.
8. Die Artikel nicht beschädigt sind.

## SICHERHEITSHINWEISE:

Die Produkte Arblu werden unter Beachtung der geltenden Sicherheitsvorschriften hergestellt, von daher ist es unabdinglich, dass für eine korrekte Installation und ein ebensolcher Gebrauch des Produkts, die nachfolgenden Hinweise beachtet werden:

1. Prüfen, ob sich die dem Beschlagsatz beiliegenden Dübel für den Wandtyp eignen, ist das nicht der Fall, benutzen Sie andere geeigneten Dübel.
2. Während der Montage muss besonders auf das Handling der Kristallglasscheiben geachtet werden, im besonderen Maße bei Duschkabinen ohne Profile, hier sind die Kanten zu schützen, denn wenn sie angeschlagen werden könnte das Kristallglas splittieren.
3. Die Duschkabine darf nur von Fachleuten benutzt werden, die über entsprechende Kenntnisse zu ihrem sicheren Gebrauch verfügen. Das Produkt darf nicht von Kindern ohne eine angezeigte Beaufsichtigung oder von behinderten Leute benutzt werden.
4. Nicht an die Griffe und Halterungen hängen.
5. An den Glasscheiben keine Zubehör anbringen, wenn sie vom Hersteller nicht entsprechend vorgerüstet sind.

## ANWEISUNGEN ZUR PFLEGE UND INSTANDHALTUNG:

Glasscheiben: für eine leichte Reinigung, sind die Glasscheiben, die bei geschlossener Tür nicht überlappen, mit einer transparenten und Antischimmelmischung ausgestattet, die leicht herausziehbar und wieder einsetzbar ist. Arblu bietet einen Reinigungsskit an, der verhindert, dass das Wasser auf der Oberfläche bleibt. Man kann aber auch ein weiches Tuch und neutrale Glasreiniger benutzen. Nach jedem Gebrauch sollten die Glasscheiben und Aluminiumprofile immer abgetrocknet werden. Wichtig ist, dass keine Scheuertücher, Pulverreiniger, Azeton oder scheuernde und scharfe Reinigungsmittel benutzt werden. Mikrofaser-tücher sind geeignet für die Reinigung von SGP behandelten Gläsern.

## GARANTIE:

Die Produkte sind ausschließlich für den Gebrauch/Einsatz geeignet, für die sie bestimmt sind, und werden durch Nichtkonformität und Material, Verarbeitungsfehler gewährleistet. In jedem Fall sind Maße, Tönungen, Farben, Abzeichnungen und Zeichnungen bei den Katalogen und/oder Muster lediglich als Indikativ zu bezeichnen. Die Garantie betrifft lediglich den Austausch des Produkts, die der Hersteller als defekt anerkennt. Ausgeschlossen von der Garantie und jegliche Haftung gegenüber von Arblu SRL ist der normale Gebrauch und Verschleiß der Produkte. Ausgeschlossen von der Garantie sind auch Mängel bei mangelhafter oder fehlerhafter Lagerung. Die Garantie entfällt, wenn die Produkte vom Käufer und/oder Dritte abgeändert wurden, und/oder manipuliert, falsch installiert und/oder für andere Zwecke benutzt wurden und nicht in Übereinstimmung mit den in der Montageanleitungen vorgesehene Nutzungsbedingungen durchgeführt werden. In keinen dieser Fälle wird die Gewährleistung von 24 (vierundzwanzig) Monaten nach Lieferung genehmigt.

## UMWELTSCHUTZ:

Das Produkt und seine Bestandteile, einschließlich der Verpackungen, dürfen nicht in der Umwelt verstreut, sondern müssen durch die geltenden Umweltschriften entsorgt werden. Falls es Probleme oder Zweifel gibt, die technische Produktkarte zu verstehen, betrachten Sie die Originalversion, auf italienisch. Diese Erklärung und die DOP sind auf der Website [www.arblu.com](http://www.arblu.com) verfügbar.

## FR FICHE DU PRODUIT

## PRINCIPAUX CARACTÉRISTIQUES DES MATÉRIAUX:

**APTITUDE AU NETTOYAGE:** les surfaces des composants des parois de douche accessibles durant l'utilisation et le nettoyage de celle-ci ne présentent ni arêtes vives, ni bavures ou bords coupants; l'emploi des détergents recommandés par le fabricant n'altère ni la sécurité ni le fonctionnement de la paroi de douche.

**RÉSISTANCE À L'IMPACT/COMPORTEMENT À L'ÉCLATEMENT:** les verres utilisés sont trempés thermiquement et satisfont les exigences des normes EN 12150-1 et EN 14428; les plaques en crillex sont des matériaux en polystyrène conformes à la norme EN 14428.

**Durabilité:** les parois de douche sont durables car elles sont conformes aux exigences suivantes:

- Aptitude au nettoyage
- Résistance à l'impact/comportement à l'éclatement
- Résistance à la corrosion / Résistance aux agents chimiques et aux taches
- Endurance / Résistance aux cycles humidité-séchage
- Stabilité
- Étanchéité

**QUALITÉ CERTIFIÉE DES PROFILS EN ALUMINIUM SELON LES MARQUES EUROPÉENNES:**

- QUALANOD pour le processus d'oxydation / QUALICOAT pour le processus de vernissage
- **MATÉRIAUX POTENTIELLEMENT ALLERGENES:** lorsque ces substances sont présentes, elles sont opportunément revêtues de matière à éviter tout contact.
- **POIGNÉES:** en zamak de finition chromée ou vernie  
en aluminium de finition chromée ou vernie  
en ABS de finition chromée ou vernie
- **BRAS AU MUR:** aluminium de finition oxydée ou vernie
- **CHARNIÈRES, ACCESSOIRES, VERRE:** charnières en zamak de finition chromée ou vernie  
accessoires plastiques en ABS, PA, PA6, PA66, PTFE, PTE avec finition dérivée du moule, chromée ou vernie  
accessoires en zamak avec finition dérivée du moule, nickelée, chromée ou vernie  
vis en acier inox A2 ou A4
- **JOINTS:** en PVC ou TPE

## INFORMATIONS GÉNÉRALES:

Avant d'installer et d'utiliser la cabine de douche, lire attentivement cette fiche et la notice de montage jointe au produit et conserver ces documents pour toute consultation ultérieure.

Avant d'installer la cabine de douche, vérifier que:

1. L'installation soit effectuée par du personnel qualifié;
2. L'alimentation d'eau soit coupée;
3. L'installation d'eau soit conforme aux règles de l'art prévues par les normes spécifiques en vigueur;
4. La prédisposition hydraulique soit conforme à la typologie du produit à installer;
5. La pièce d'installation de la cabine soit adéquate à la typologie du produit à installer;
6. Le mur d'appui de la cabine de douche soit adapté à ces fins. Prêter une attention particulière aux murs en placoplâtre ou en autre matériau non équipés de manière adéquate;
7. Le contenu de l'emballage soit conforme au produit commandé;
8. Les articles n'aient subi aucun dommage.

## AVERTISSEMENTS EN MATIÈRE DE SÉCURITÉ:

Les produits Arblu sont fabriqués conformément aux normes de sécurité en vigueur. Il faut donc respecter les avertissements indiqués ci-dessous afin d'une bonne installation et d'un bon emploi du produit:

1. Vérifier que les chevilles du kit de visserie en dotation soient adaptées au type de mur. En cas contraire, utiliser des chevilles appropriées;
2. Il est recommandé d'adopter la plus grande précaution pour le déplacement des vitres en phase de montage, notamment pour les cabines sans profils, ceci en protégeant les arêtes pour éviter de briser le verre en cas de choc;
3. La cabine de douche doit être utilisée par des personnes dûment informées sur son utilisation en toute sécurité; le produit n'est pas adapté à l'emploi par des personnes handicapées et par des enfants sans surveillance;
4. Ne pas se suspendre aux poignées ni aux bras.
5. N'installer aucun accessoire sur la vitre si non déjà prévu par le fabricant

## INSTRUCTIONS D'ENTRETIEN ET DE MAINTENANCE:

Vitres: pour faciliter le nettoyage, les vitres ne sont pas superposées à porte fermée et sont équipées par de joints transparents anti-moissure, faciles à retirer et à remplacer. Arblu propose un kit de nettoyage empêchant l'eau de stagner sur les surfaces; il est également possible d'utiliser un chiffon doux et les détergents neutres spécifiques pour le verre. Il est toujours conseillé d'essuyer les verres et les profils en aluminium à la fin de chaque utilisation. Il est important de n'utiliser ni chiffons abrasifs, ni acétone, ni détergents en poudre, abrasifs et/ou agressifs. Pour le verre traité avec SGP, l'utilisation de chiffons en microfibrés n'est pas recommandée.

## GARANTIE:

Les produits sont prévus à l'emploi auquel ils sont habituellement destinés et seront garantis pour non-conformité et défauts de matériaux et fabrication. En tout cas, dimensions, peintures, couleurs, illustration et dessins de catalogues et/ou échantillons sont purement indicatifs. La garantie comporte seulement le remplacement des produits et/ou des composants que Arblu srl considèrera défectueux.

La normale dégradation et l'usure des produits excluent Arblu srl de toute responsabilité et garantie, ainsi que les fautes et les défauts de qualité dus ou dérivés à un mauvais stockage ou conservation. La garantie ne couvre pas les produits qui ont subi des modifications de la part de l'acheteur et/ou de tiers, qui ont été altérés, installés et/ou utilisés non conformément aux notices d'emploi prévues et remises avec le produit.

En aucun cas Arblu srl interviendra sous garantie après 24 (vingt-quatre) mois de la livraison.

## PROTECTION DE L'ENVIRONNEMENT:

Le produit et ses composants, y compris les emballages, ne doivent pas être dispersés dans l'environnement, mais éliminés conformément à la législation environnementale en vigueur. Dans le cas où il y a des doutes ou difficultés de compréhension de cette fiche produit, prendre toujours en considération la version originale, rédigée en langue italienne. Cette déclaration et la DOP sont disponibles sur le site [www.arblu.com](http://www.arblu.com)

**ESTENSIBILITA' / EXTENSIBILITY  
DEHNBARKEIT / EXTENSIBILITE**

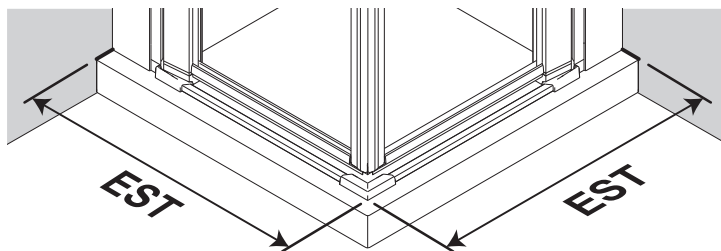

**SIGILLATURA / SEALING  
VERSIEGELUNG / ETANCHEITE**

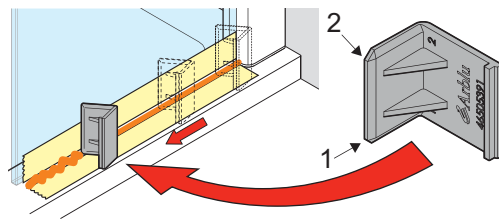
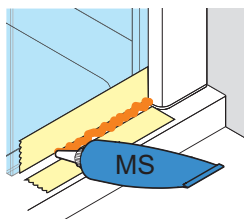
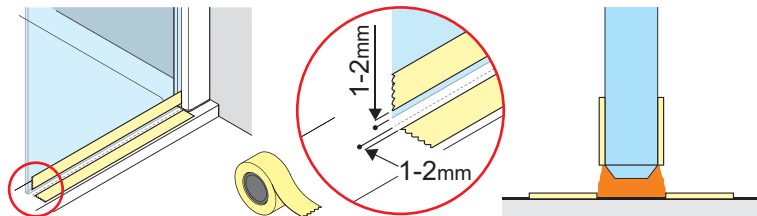

**GUARNIZIONI  
GASKETS  
LEISTEN  
JOINTS**

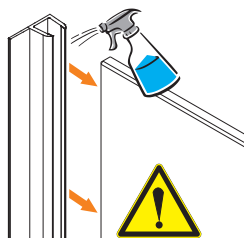

**MANIGLIA / HANDLE  
GRIFF / POIGNEE**

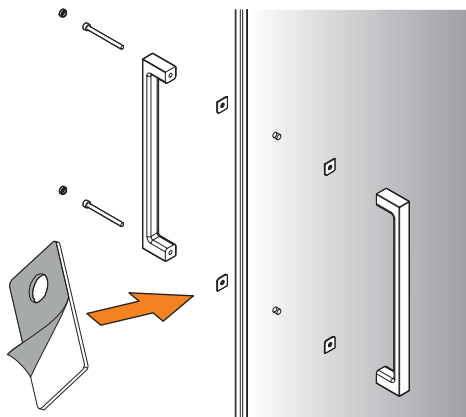

**GUARNIZIONI MAGNETICHE  
MAGNETIC GASKETS  
MAGNETLEISTEN  
JOINTS MAGNETIQUE**

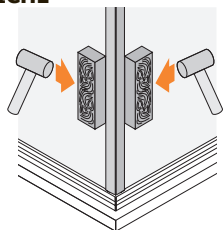
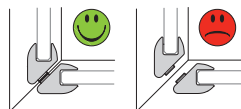



FERRAMENTA / HARDWARE KIT / EISENWAREN-KIT / QUINCAILLERIE

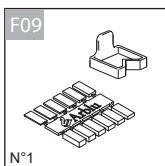
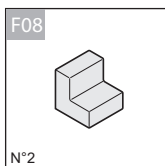
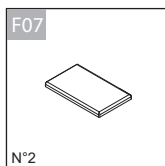
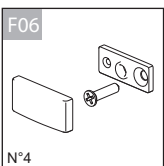
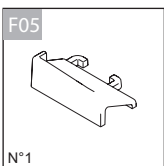
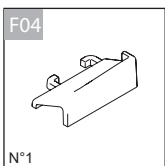
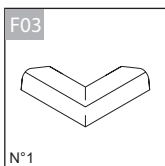
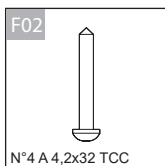
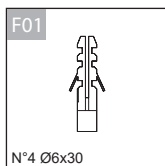
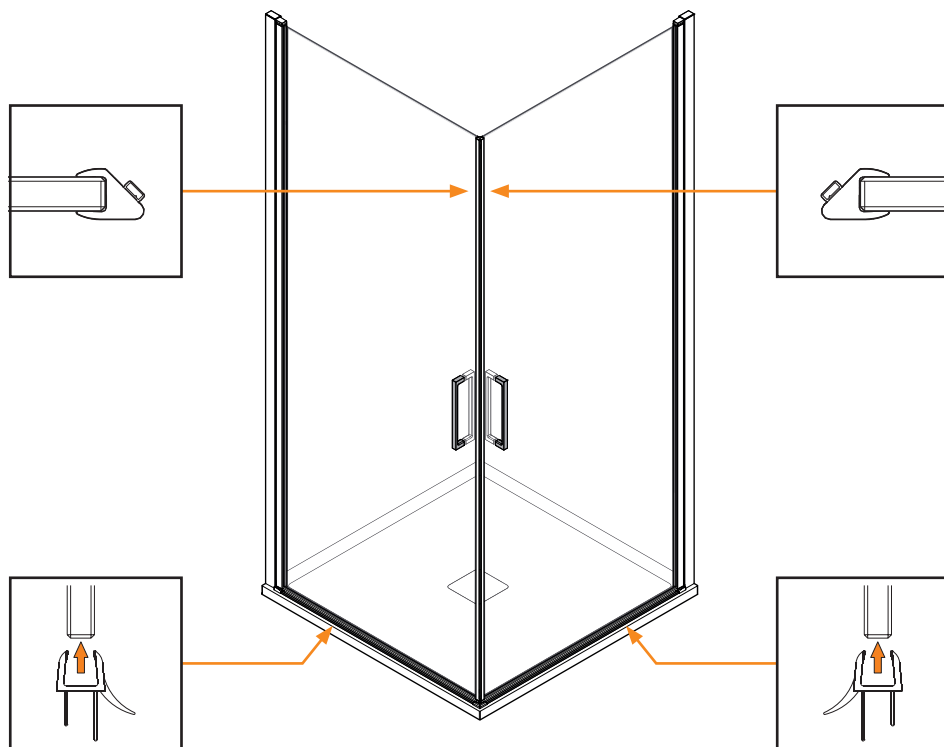

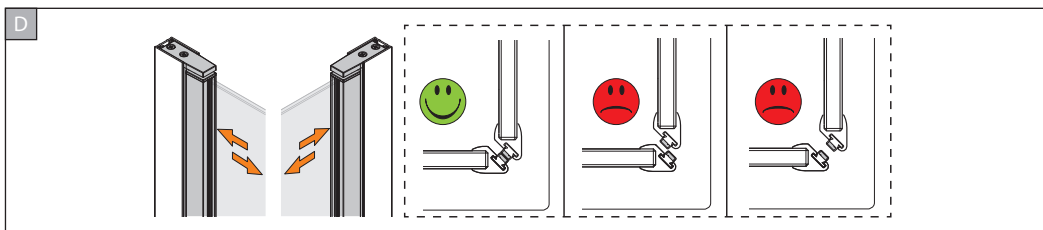
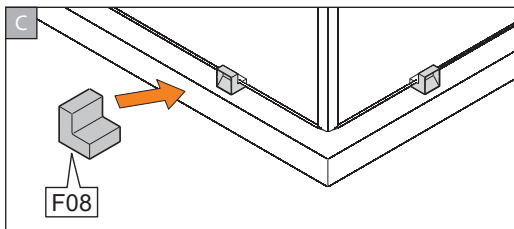
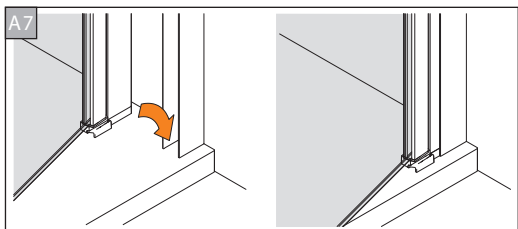
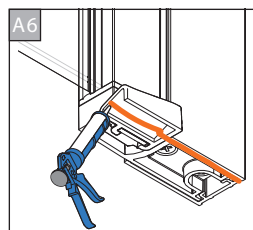
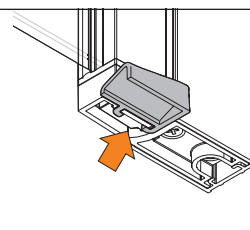
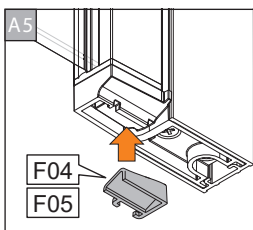
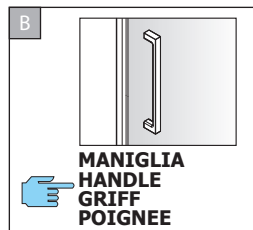
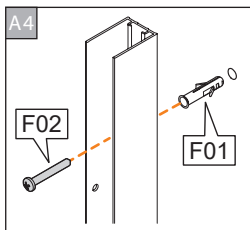
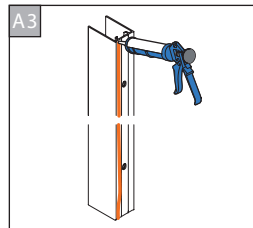
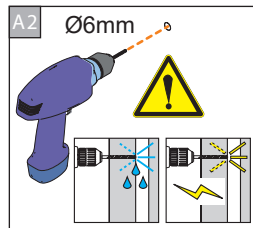
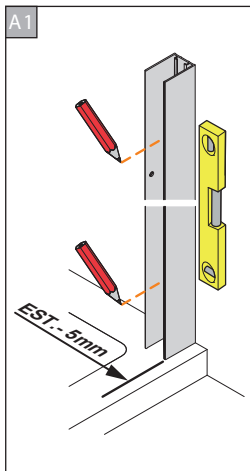
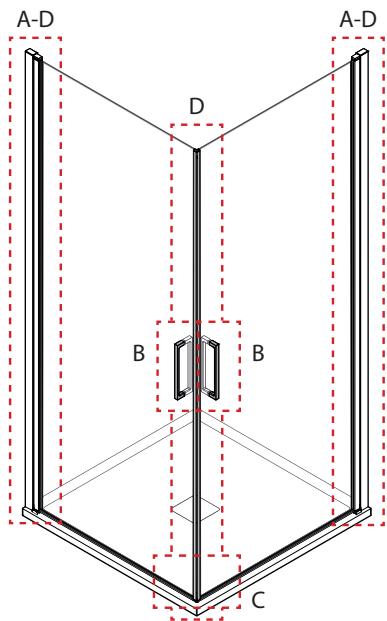

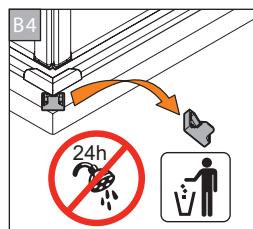
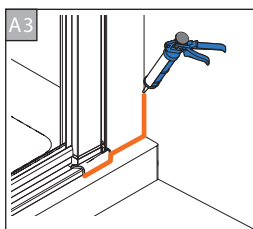
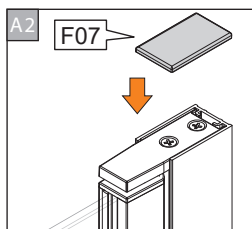
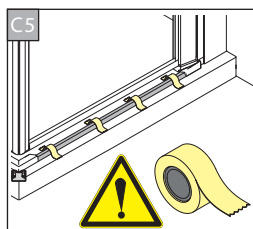
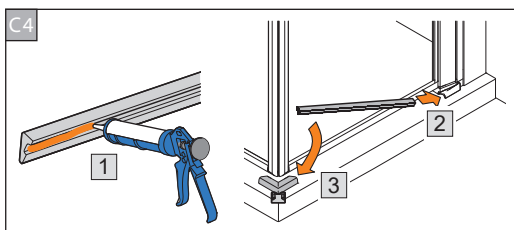
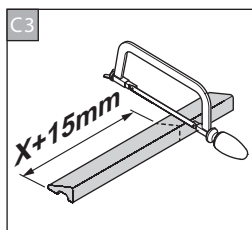
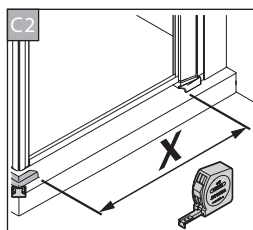
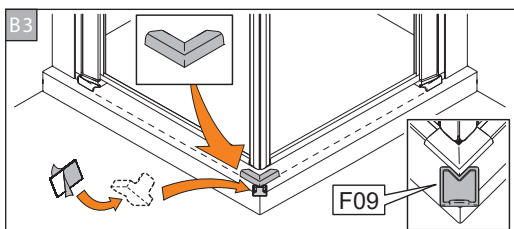
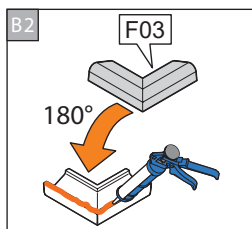
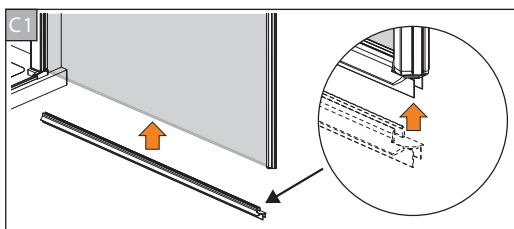
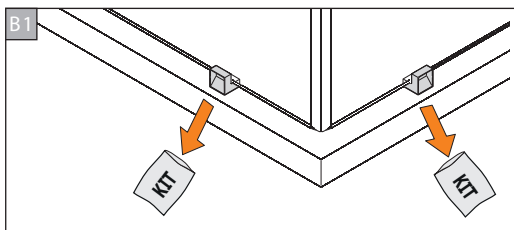
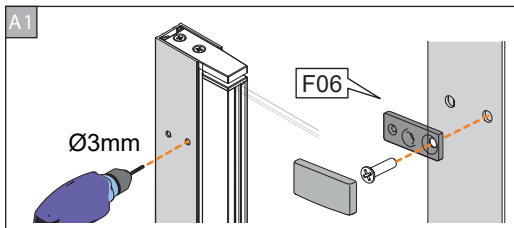
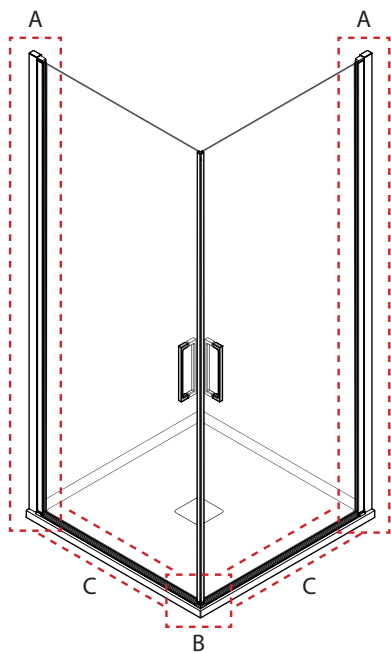

FERRAMENTA / HARDWARE KIT / EISENWAREN-KIT / QUINCAILLERIE

INSTALLAZIONE DESTRA (la sinistra è speculare)

INSTALLATION RIGHT VERSION (left is specular)

MONTAGE DER RECHTSSAUSFÜHRUNG (link ist spiegelgleich)

INSTALLATION DROITE ( la gauche est speculaire)

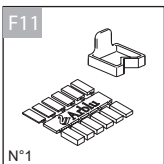
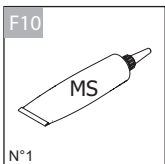
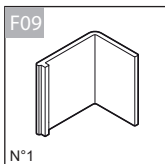
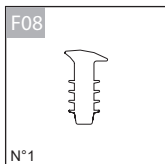
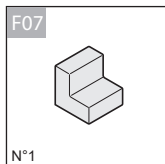
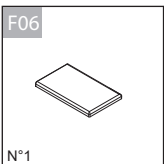
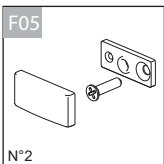
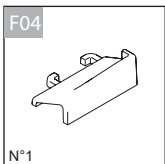
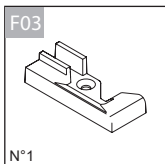
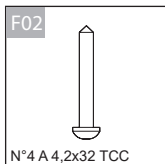
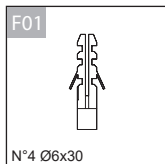
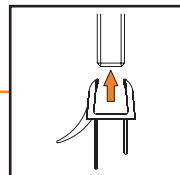
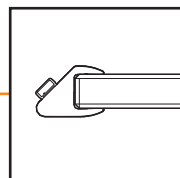
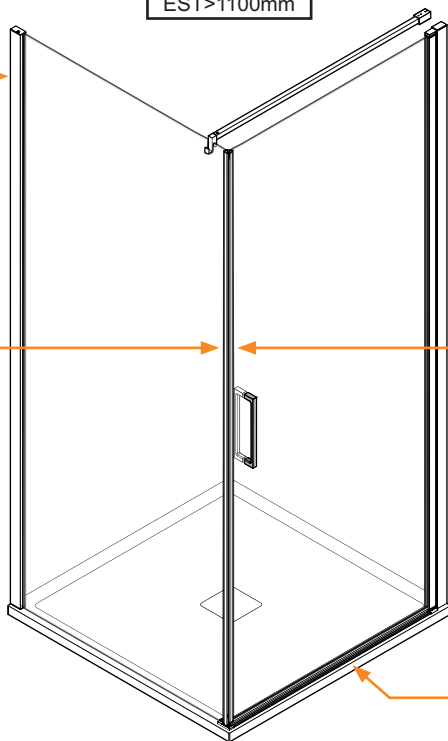
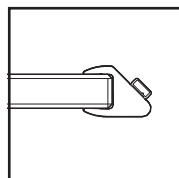
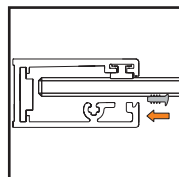
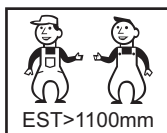

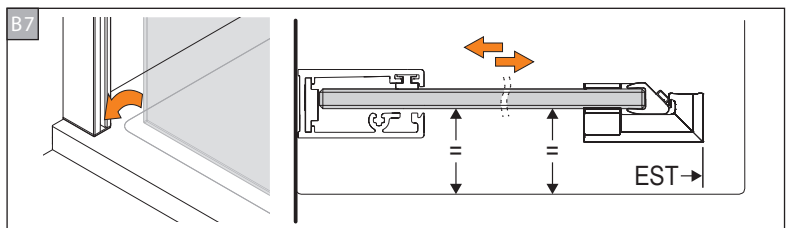
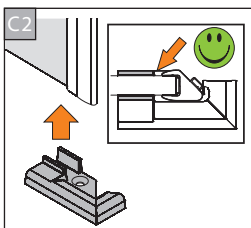
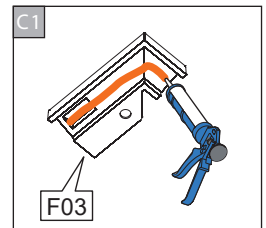
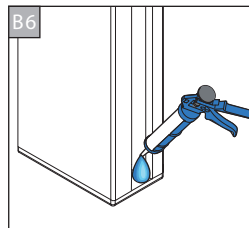
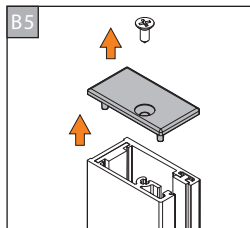
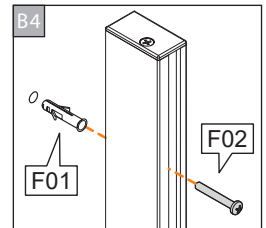
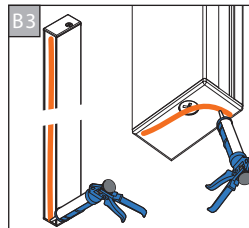
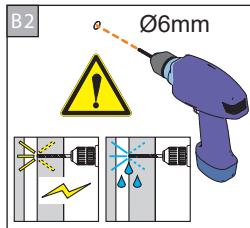
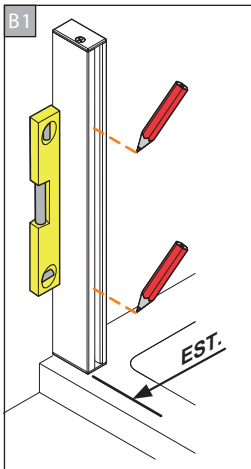
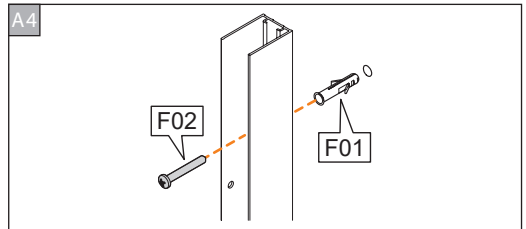
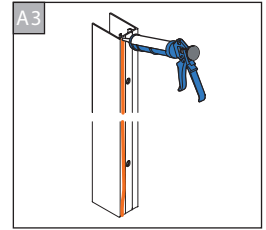
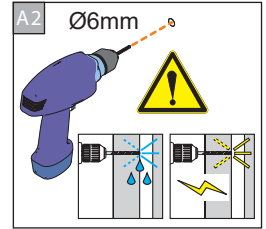
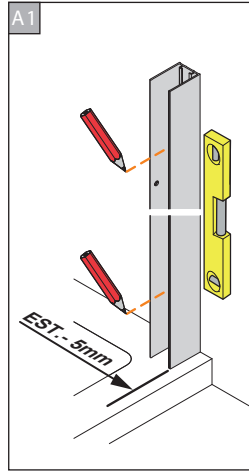
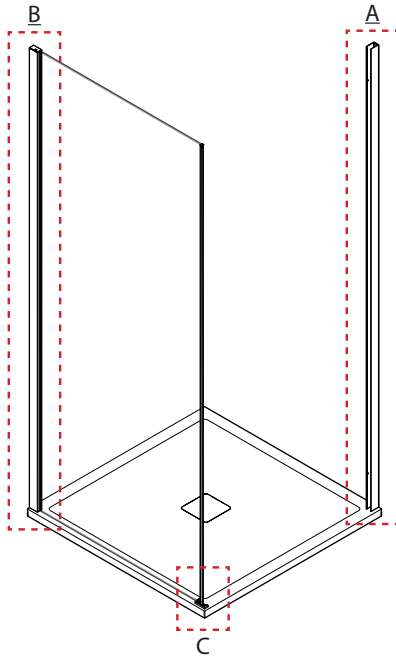

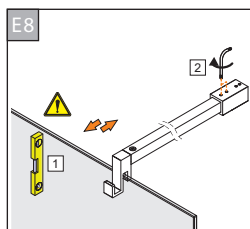
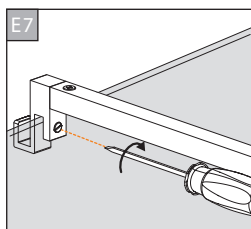
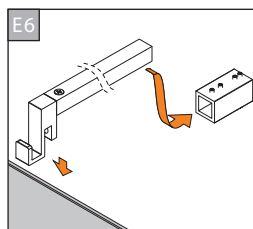
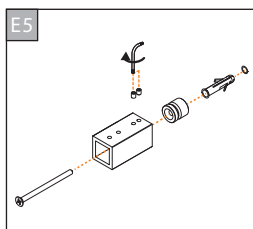
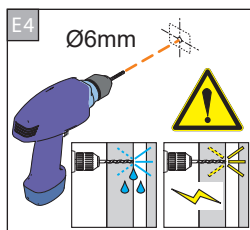
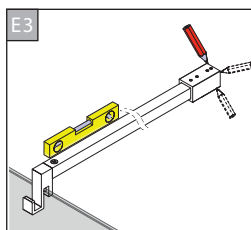
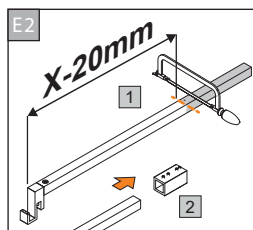
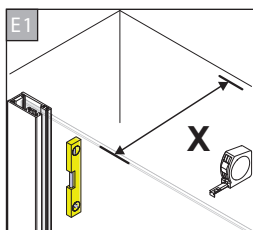
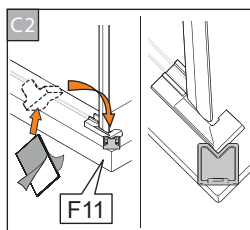
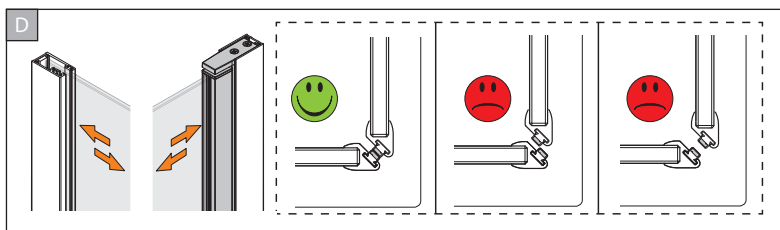
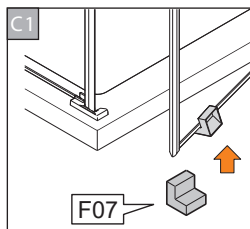
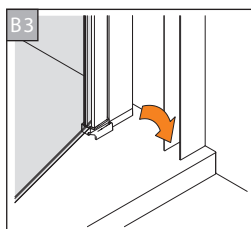
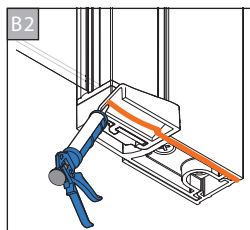
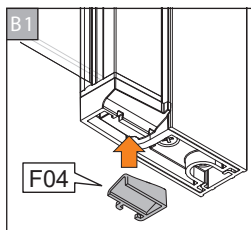
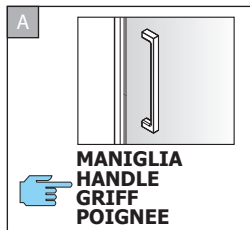
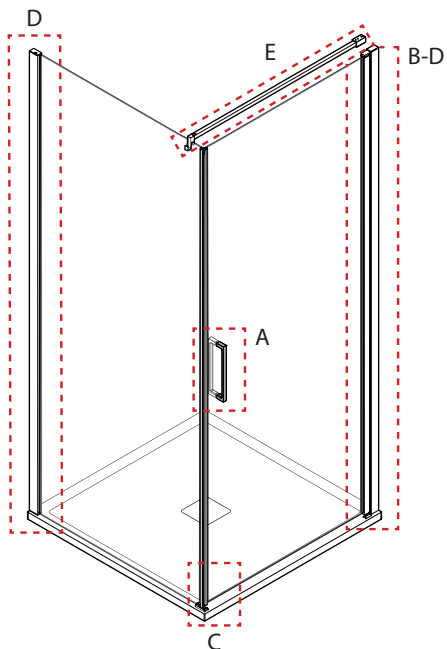

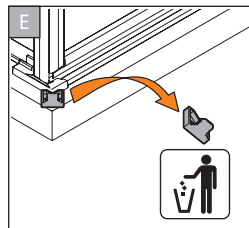
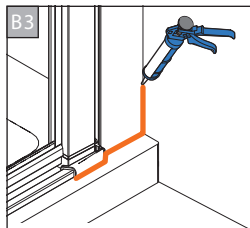
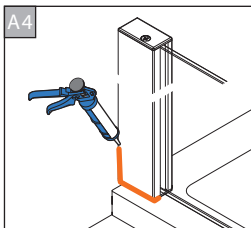
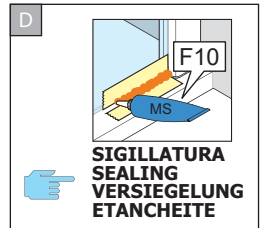
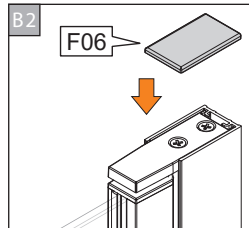
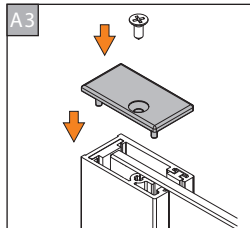
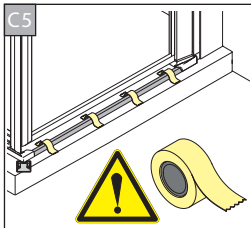
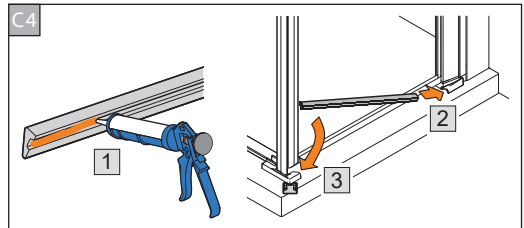
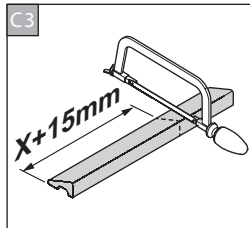
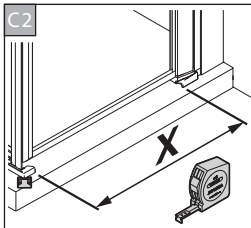
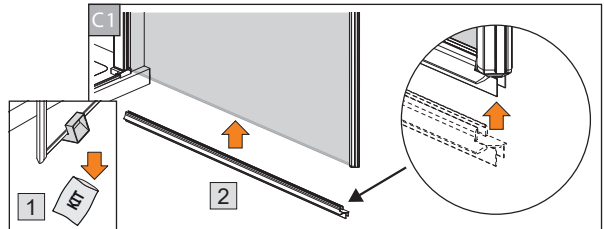
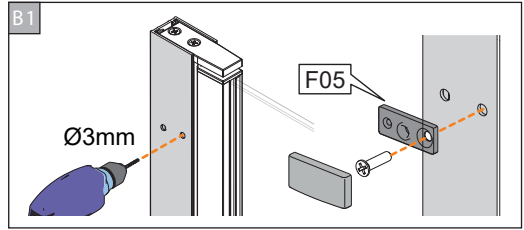
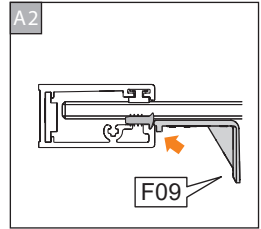
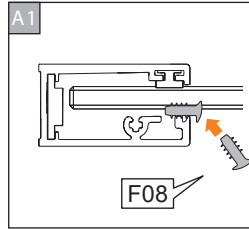
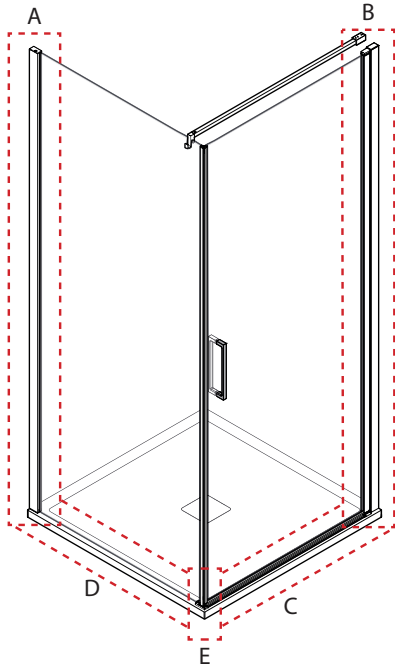

FERRAMENTA / HARDWARE KIT / EISENWAREN-KIT / QUINCAILLERIE

INSTALLAZIONE DESTRA (la sinistra è speculare)

INSTALLATION RIGHT VERSION (left is specular)

MONTAGE DER RECHTSSAUSFÜHRUNG (link ist spiegelgleich)

INSTALLATION DROITE ( la gauche est speculaire)

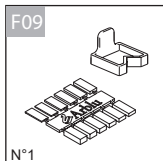
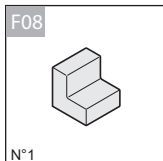
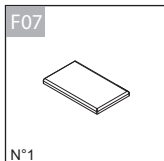
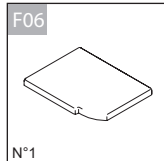
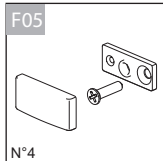
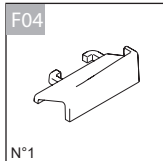
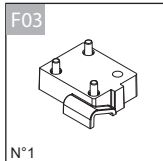
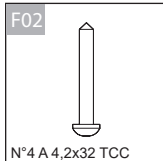
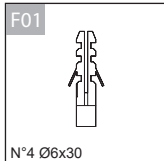
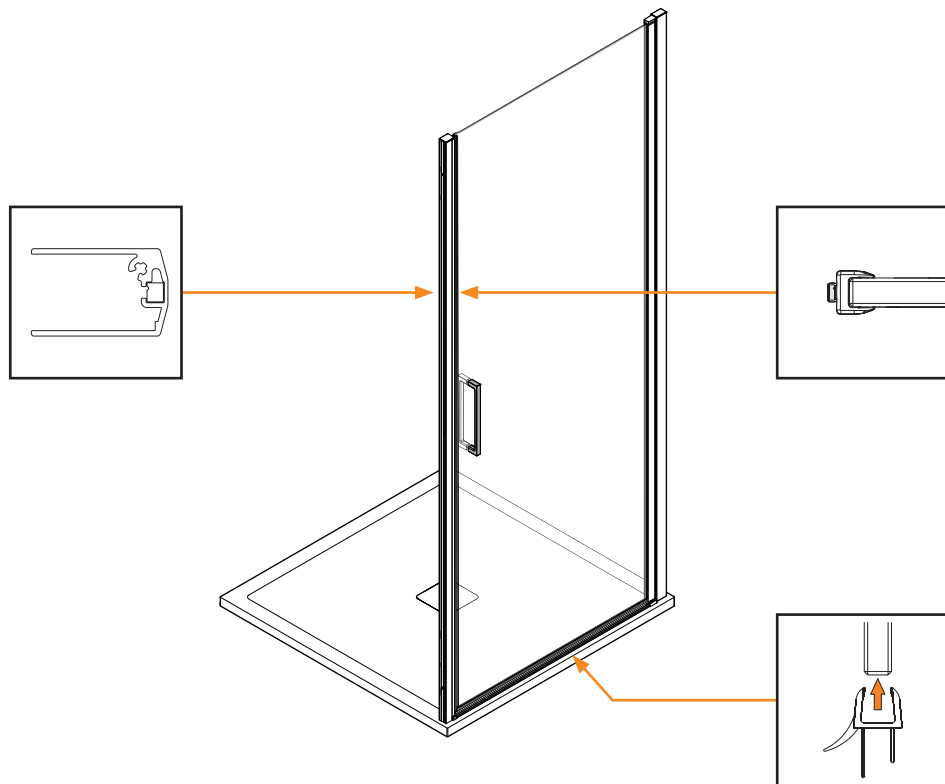



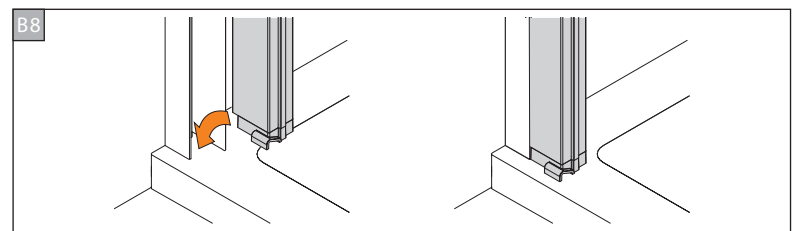
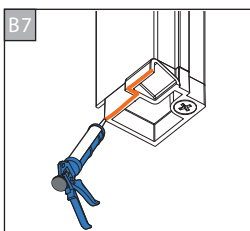
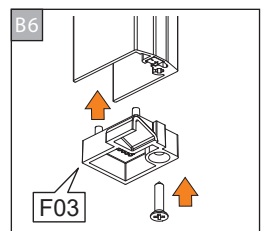
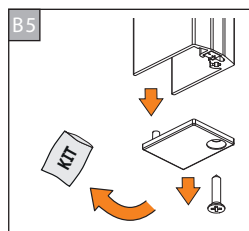
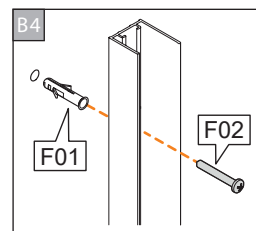
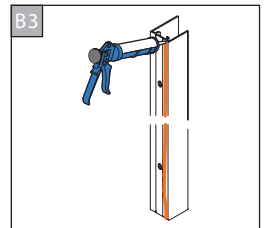
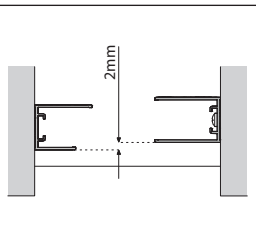
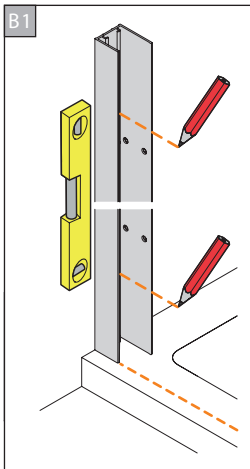
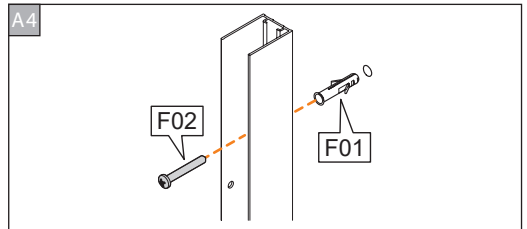
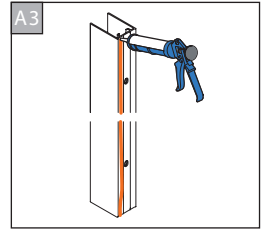
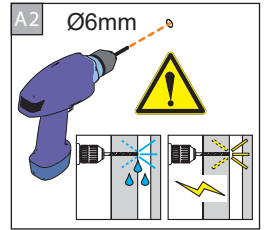
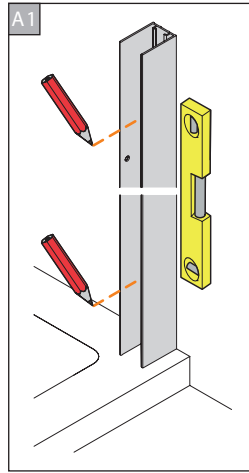
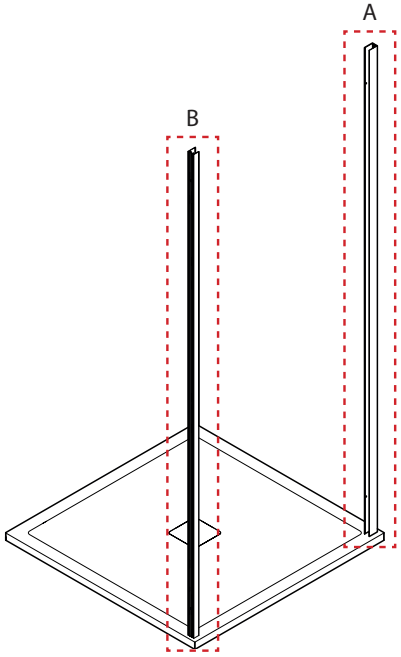

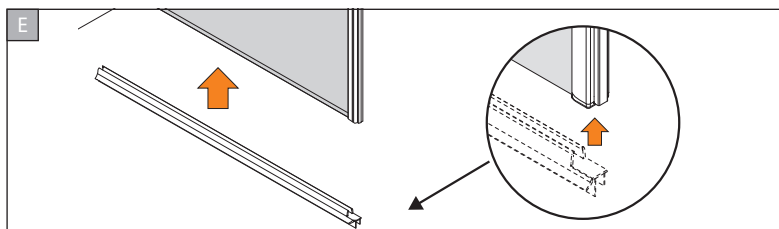
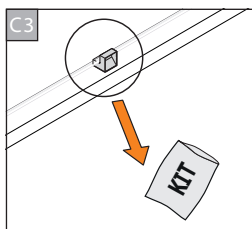
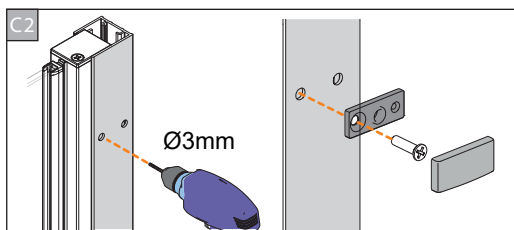
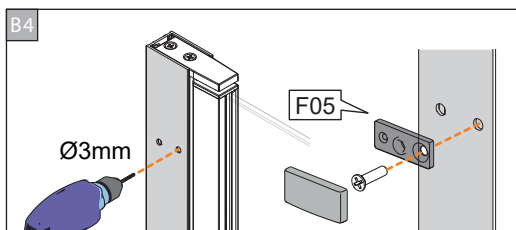
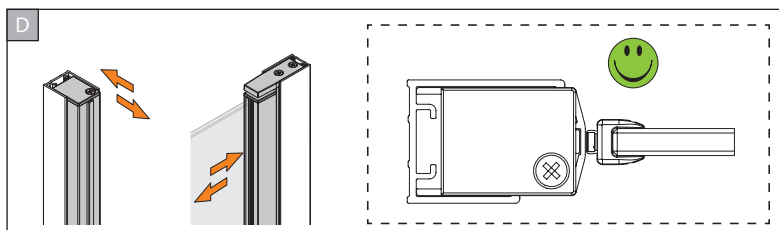
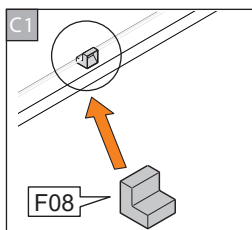
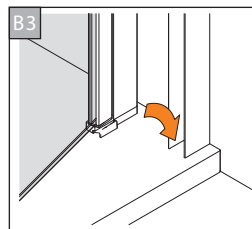
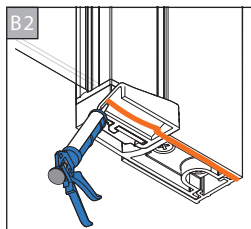
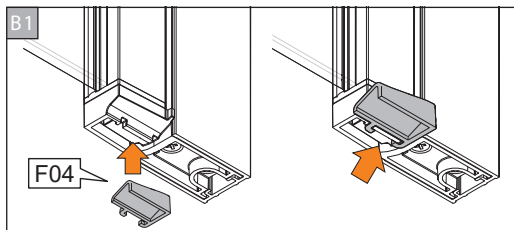
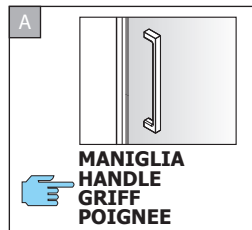
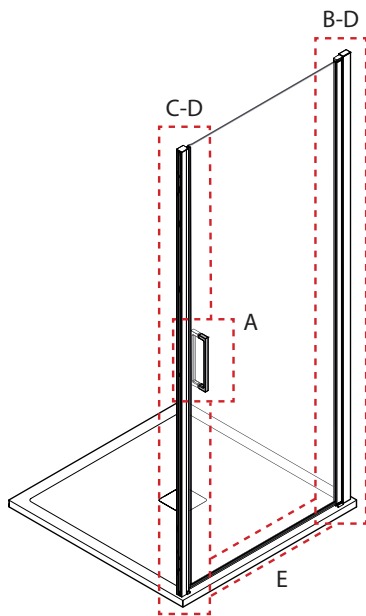

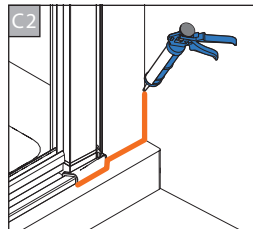
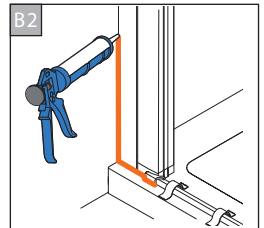
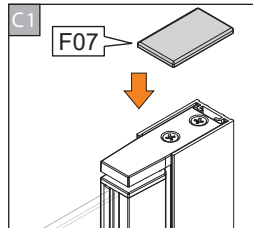
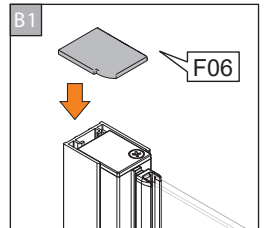
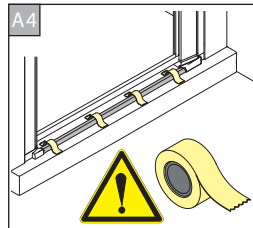
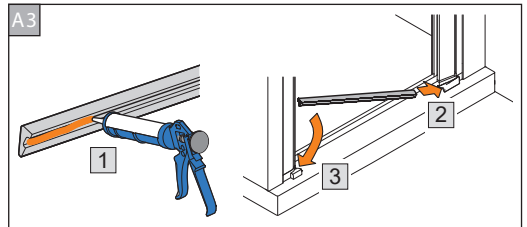
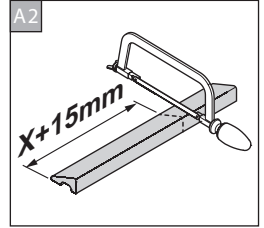
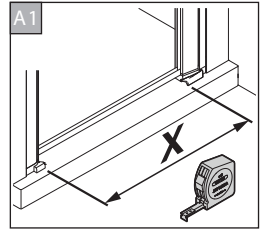
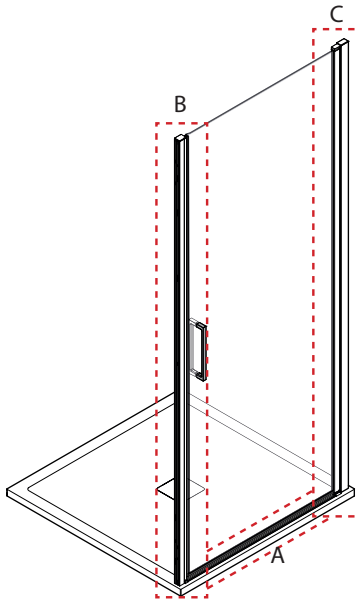

FERRAMENTA / HARDWARE KIT / EISENWAREN-KIT / QUINCAILLERIE

INSTALLAZIONE DESTRA (la sinistra è speculare)

INSTALLATION RIGHT VERSION (left is specular)

MONTAGE DER RECHTSSAUSFÜHRUNG (link ist spiegelgleich)

INSTALLATION DROITE ( la gauche est speculaire)

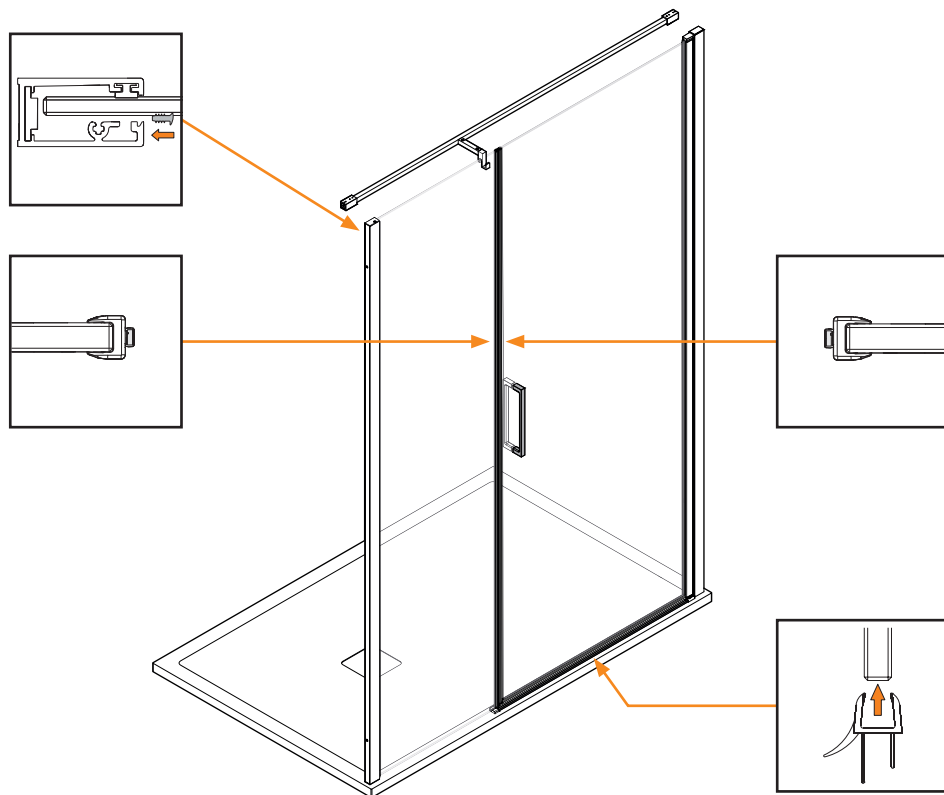

<p>F01</p> <p>N°4 Ø6x30</p>	<p>F02</p> <p>N°4 A 4,2x32 TCC</p>	<p>F03</p> <p>N°1</p>	<p>F04</p> <p>N°1</p>	<p>F05</p> <p>N°2</p>	<p>F06</p> <p>N°1</p>
<p>F07</p> <p>N°1</p>	<p>F08</p> <p>N°1</p>	<p>F09</p> <p>N°1</p>	<p>F10</p> <p>N°1</p>	<p>F11</p> <p>N°1</p>	

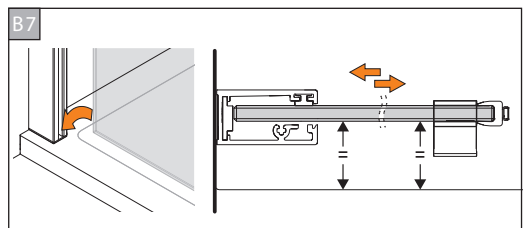
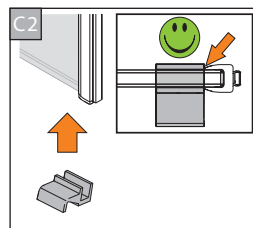
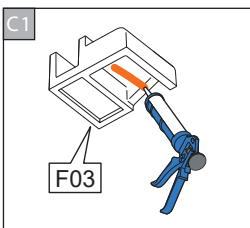
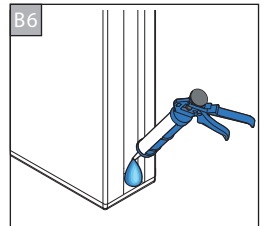
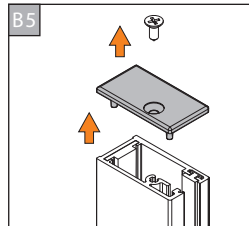
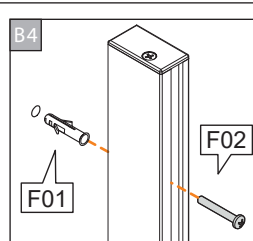
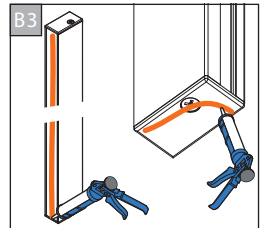
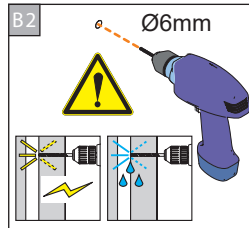
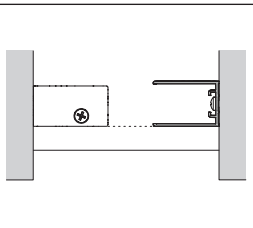
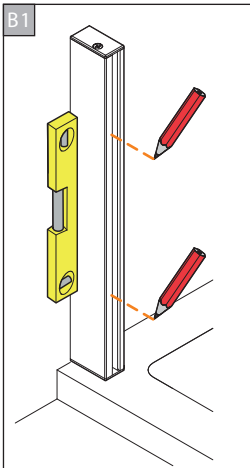
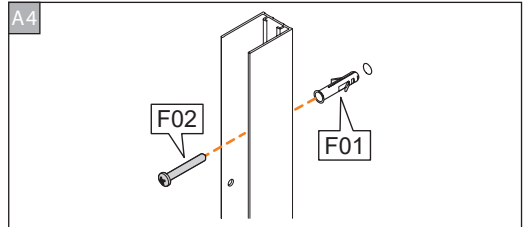
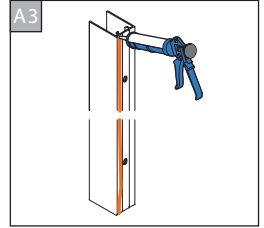
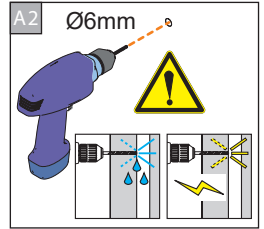
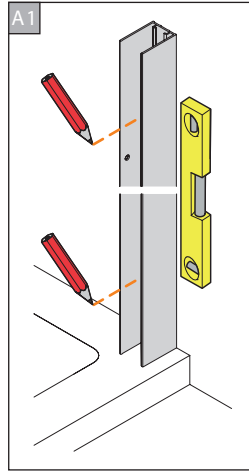
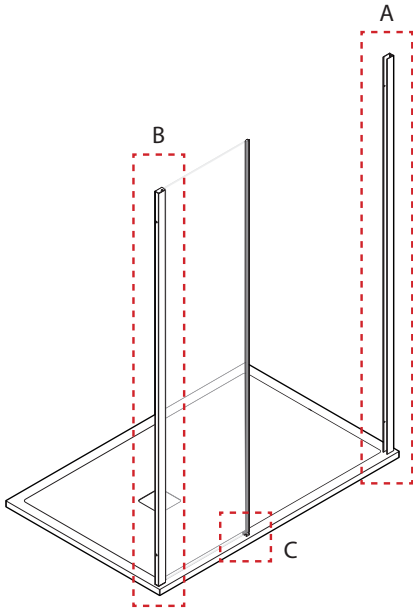

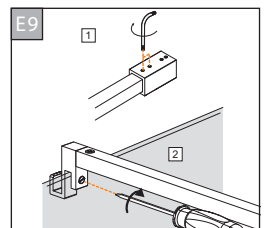
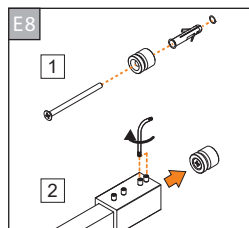
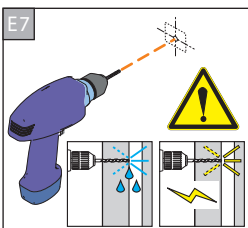
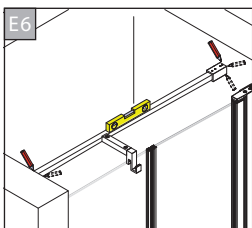
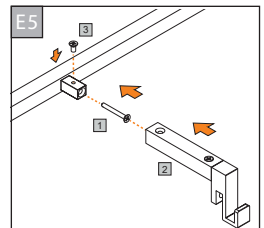
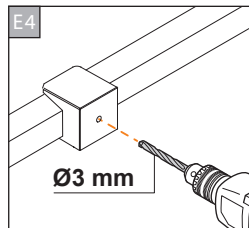
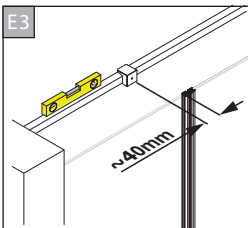
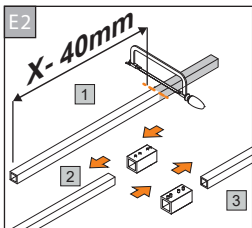
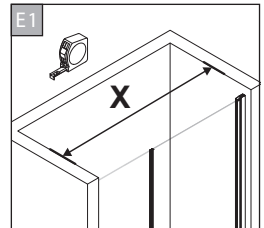
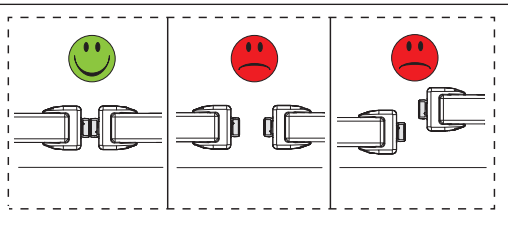
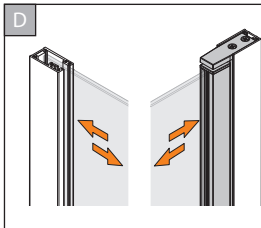
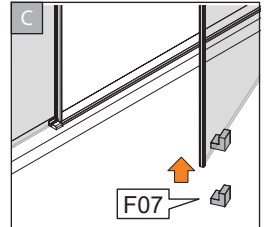
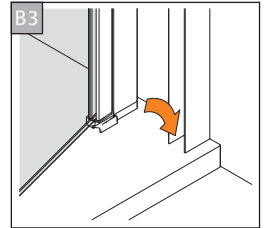
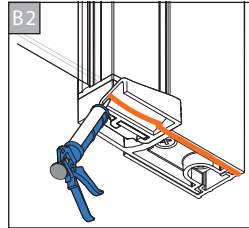
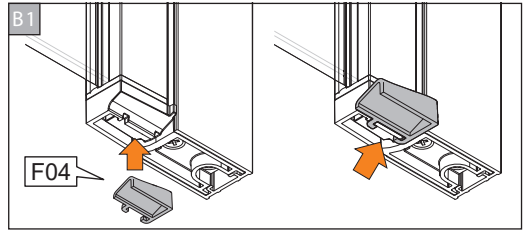
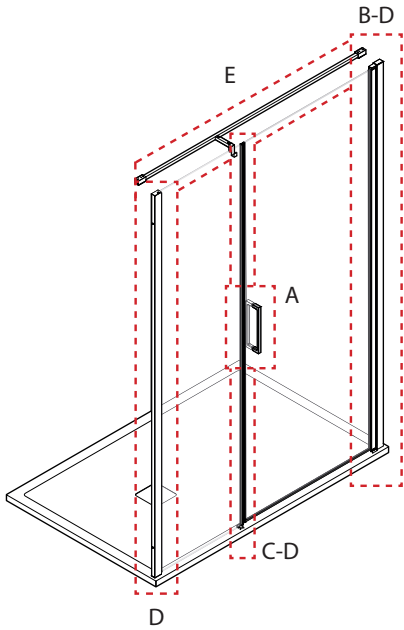

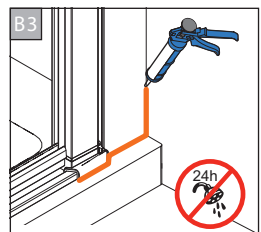
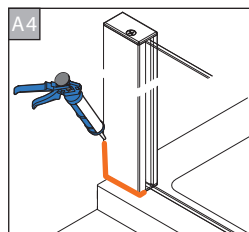
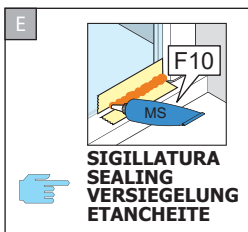
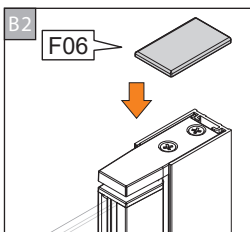
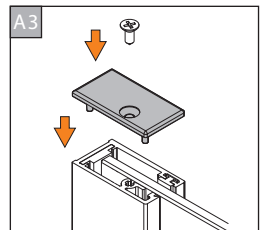
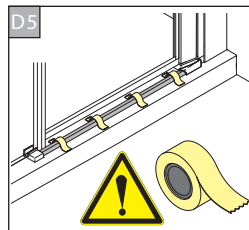
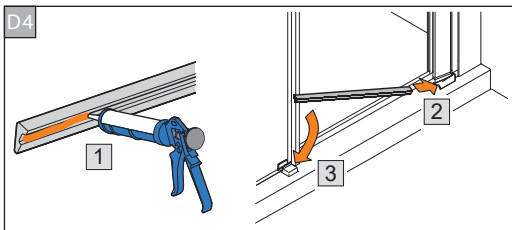
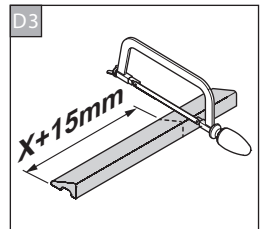
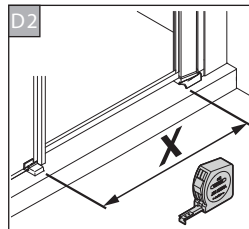
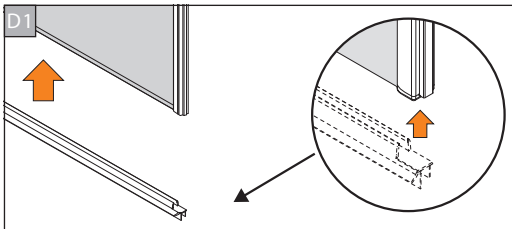
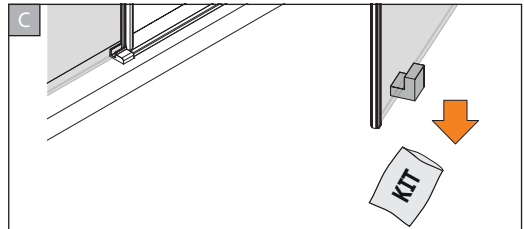
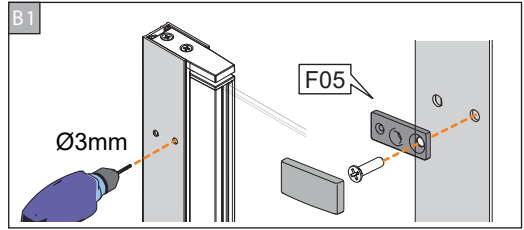
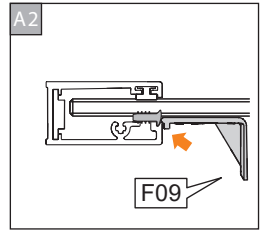
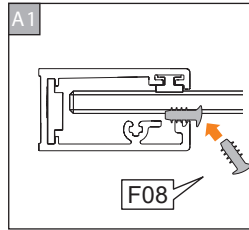
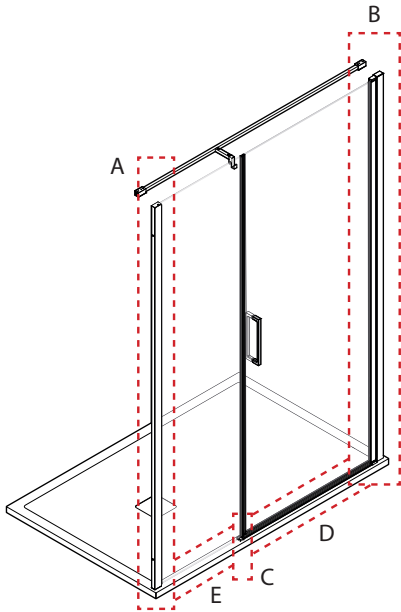

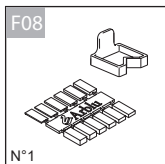
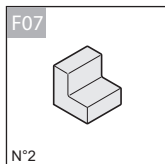
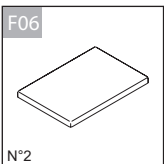
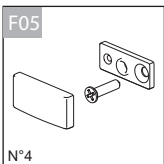
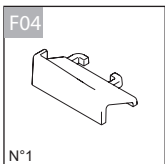
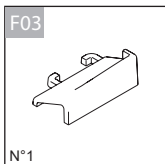
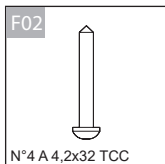
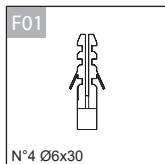
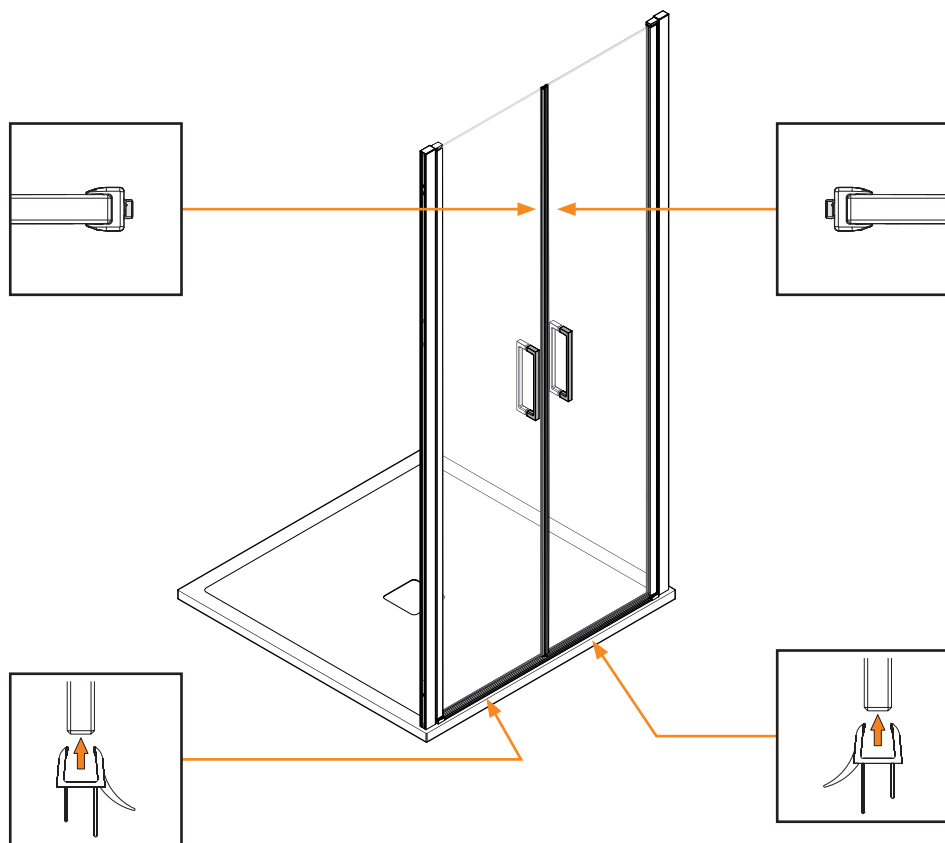



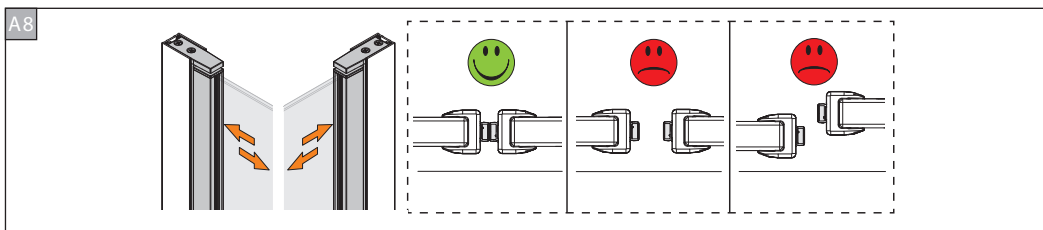
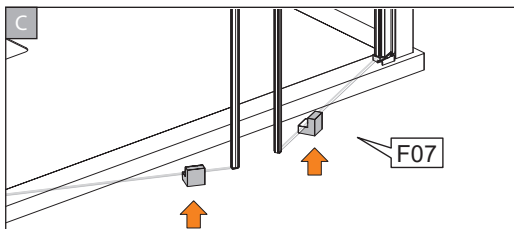
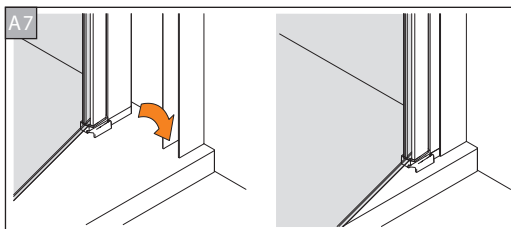
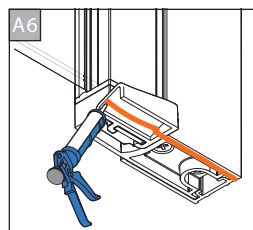
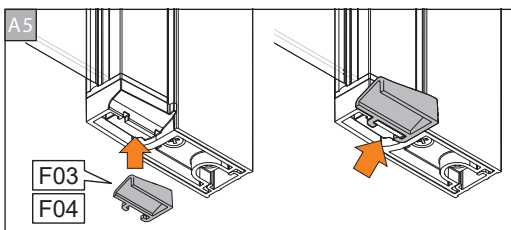
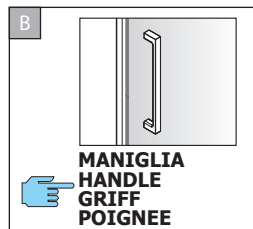
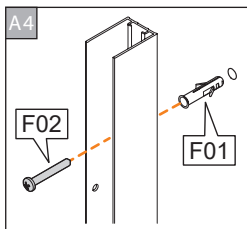
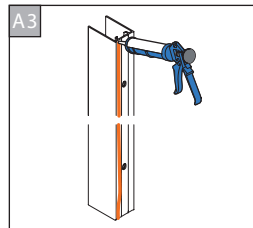
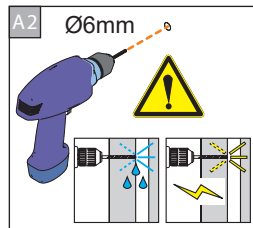
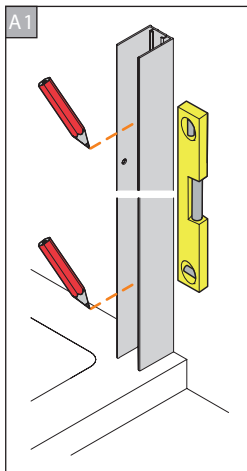
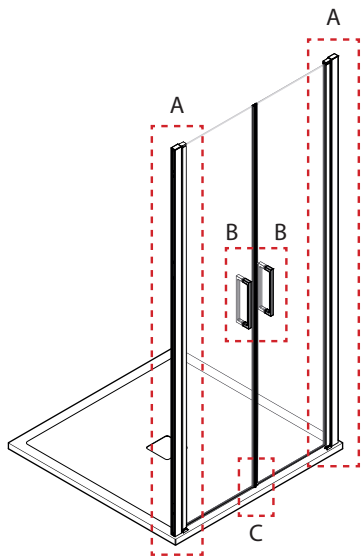

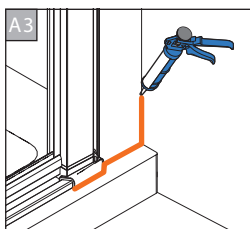
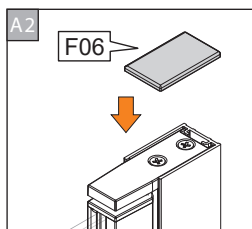
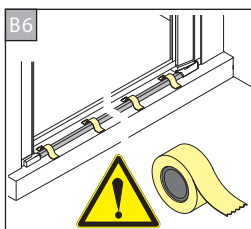
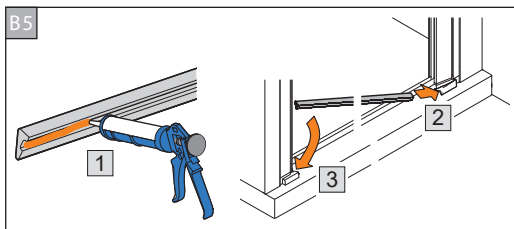
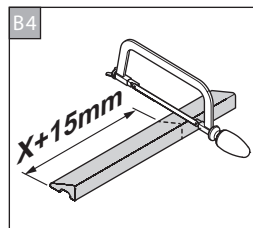
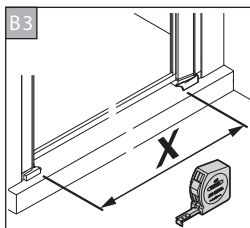
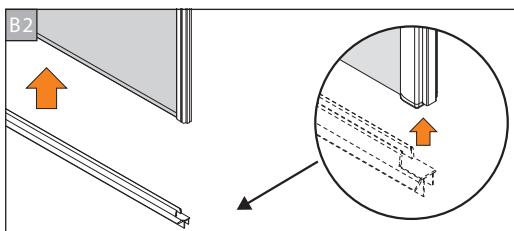
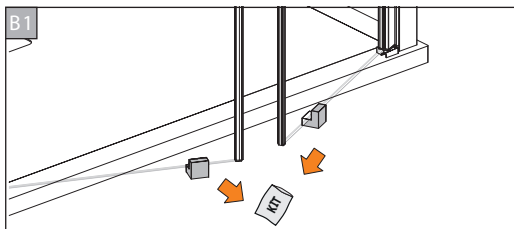
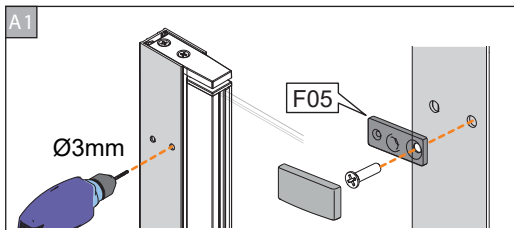
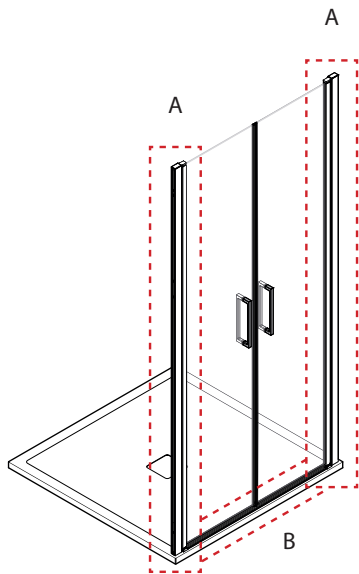

FERRAMENTA / HARDWARE KIT / EISENWAREN-KIT / QUINCAILLERIE

INSTALLAZIONE DESTRA (la sinistra è speculare)  
 INSTALLATION RIGHT VERSION (left is specular)  
 MONTAGE DER RECHTSSAUSFÜHRUNG (link ist spiegelgleich)  
 INSTALLATION DROITE ( la gauche est speculaire)

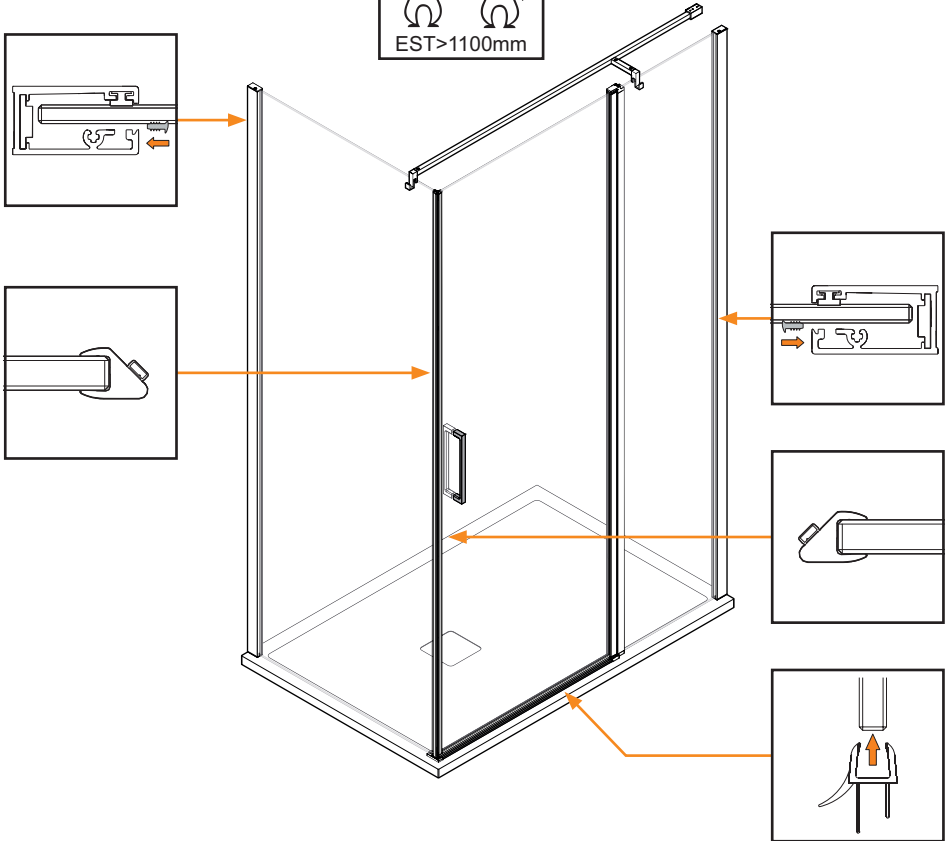
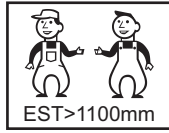

<p>F01</p> <p>N°4 Ø6x30</p>	<p>F02</p> <p>N°4 A 4,2x32 TCC</p>	<p>F03</p> <p>N°1</p>	<p>F04</p> <p>N°1</p>	<p>F05</p> <p>N°1</p>	<p>F06</p> <p>N°1</p>
<p>F07</p> <p>N°1</p>	<p>F08</p> <p>N°1</p>	<p>F09</p> <p>N°1</p>			

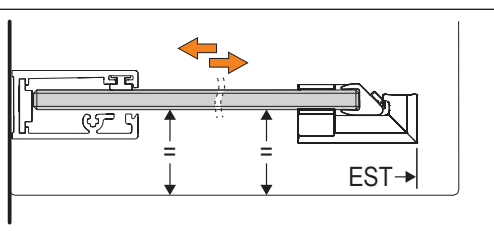
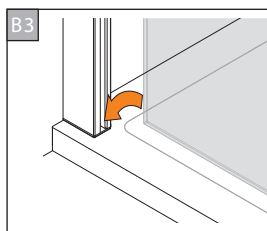
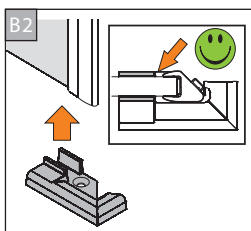
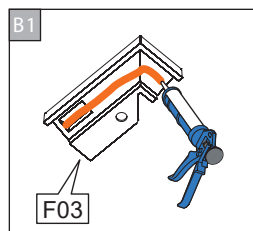
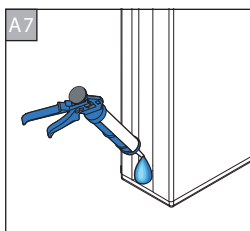
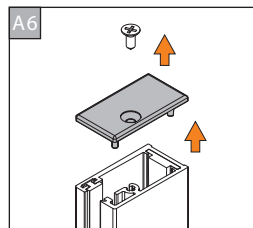
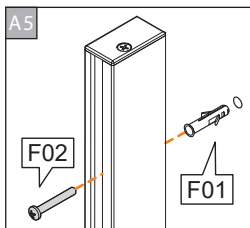
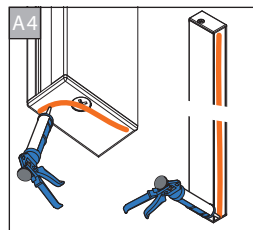
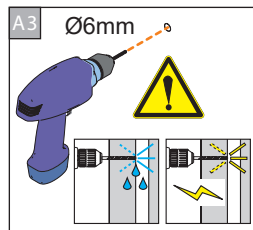
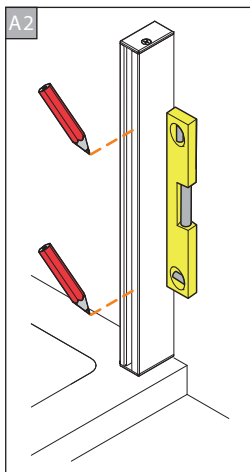
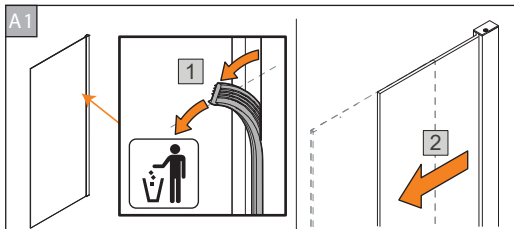
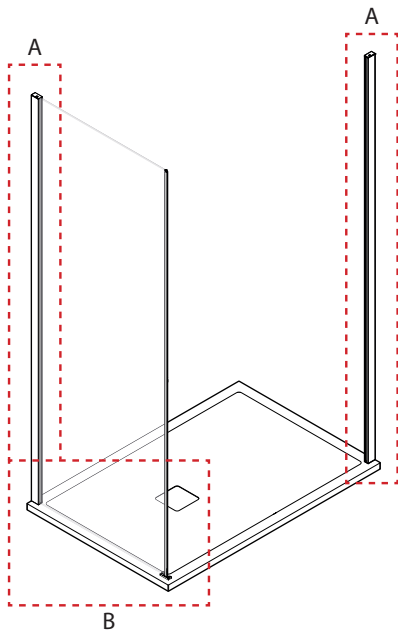

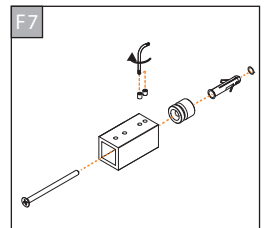
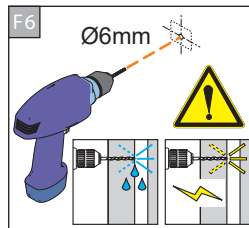
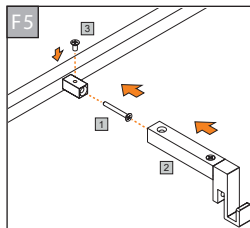
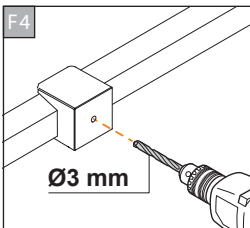
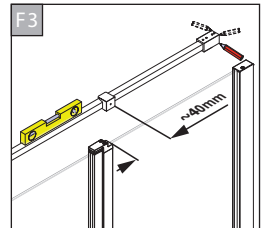
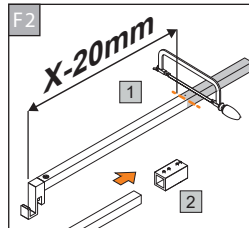
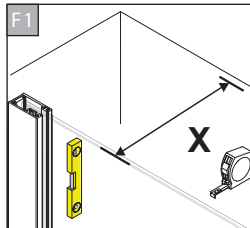
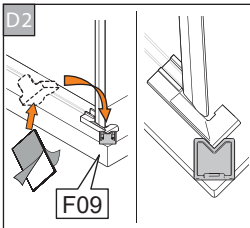
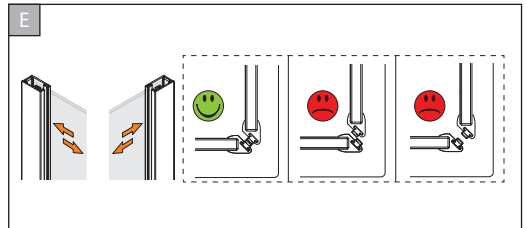
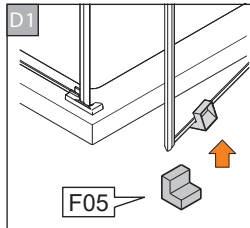
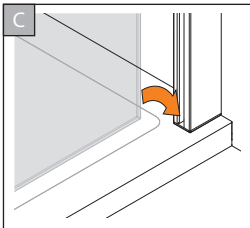
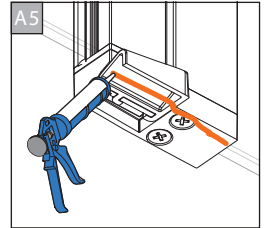
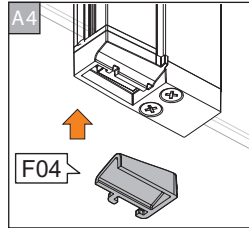
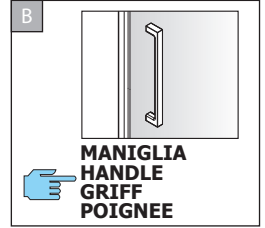
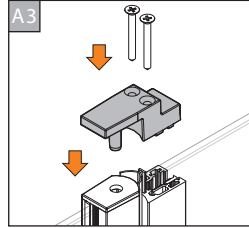
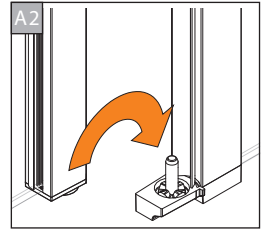
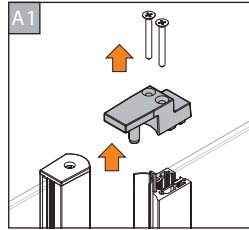
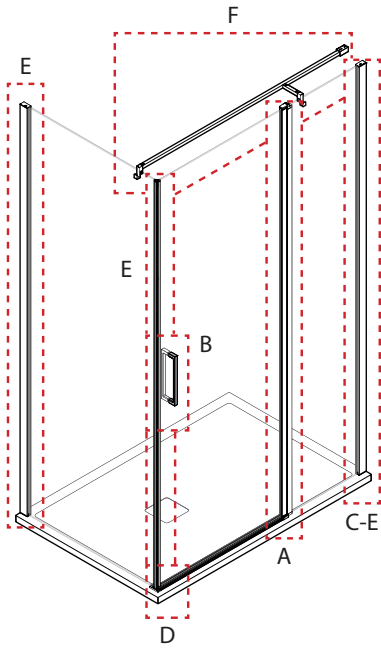

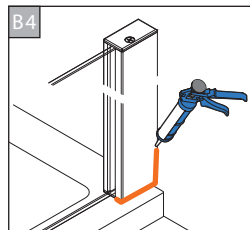
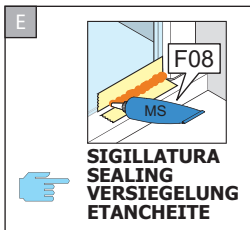
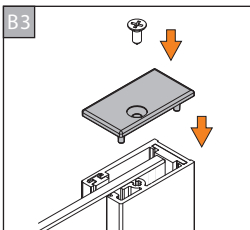
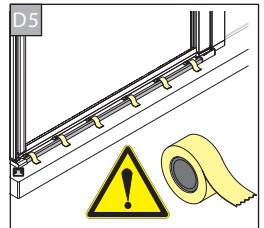
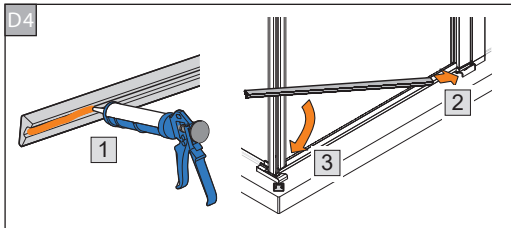
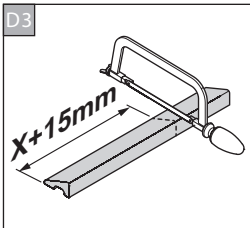
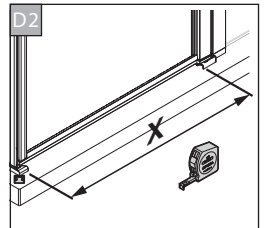
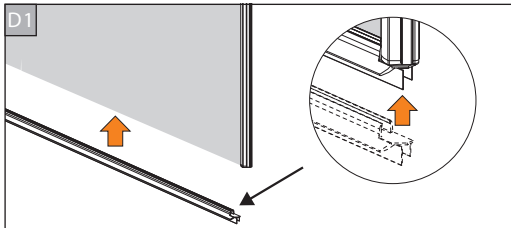
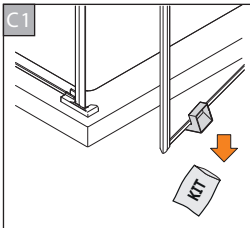
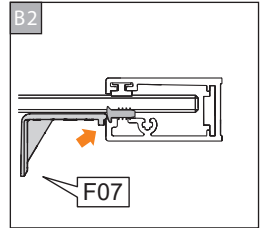
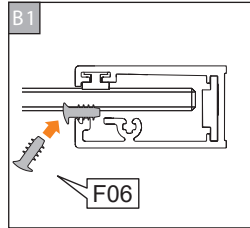
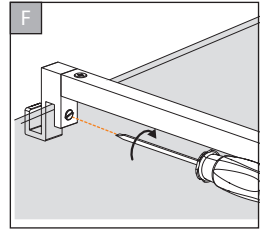
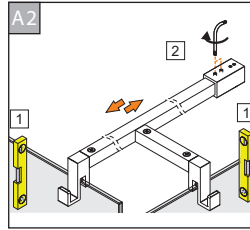
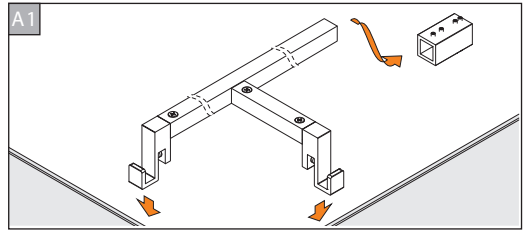
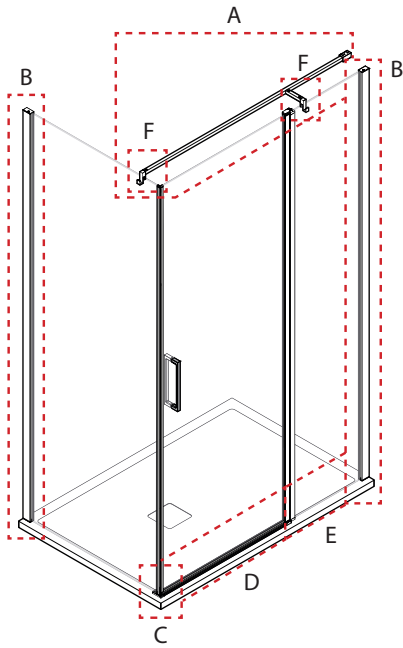

FERRAMENTA / HARDWARE KIT / EISENWAREN-KIT / QUINCAILLERIE

INSTALLAZIONE DESTRA (la sinistra è speculare)  
 INSTALLATION RIGHT VERSION (left is specular)  
 MONTAGE DER RECHTSSAUSFÜHRUNG (link ist spiegelgleich)  
 INSTALLATION DROITE ( la gauche est speculaire)

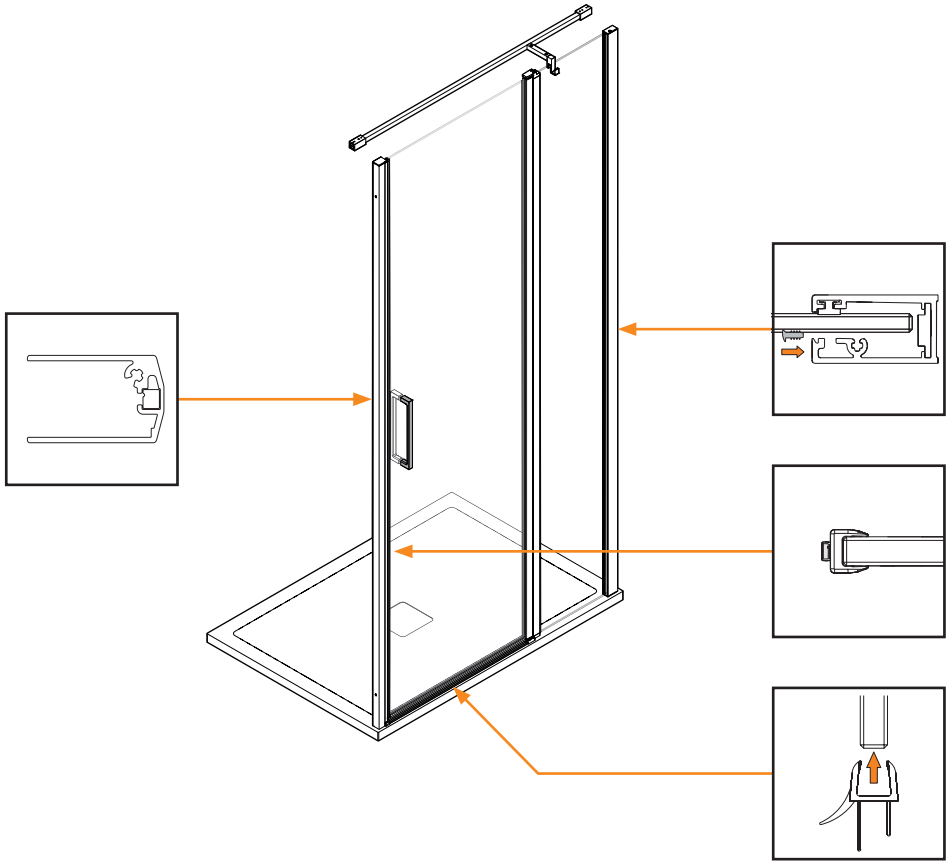

<p>F01</p> <p>N°4 Ø6x30</p>	<p>F02</p> <p>N°4 A 4,2x32 TCC</p>	<p>F03</p> <p>N°1</p>	<p>F04</p> <p>N°1</p>	<p>F05</p> <p>N°2</p>	<p>F06</p> <p>N°1</p>
<p>F07</p> <p>N°1</p>	<p>F08</p> <p>N°1</p>	<p>F09</p> <p>N°1</p>	<p>F10</p> <p>N°1</p>	<p>F11</p> <p>N°1</p>	

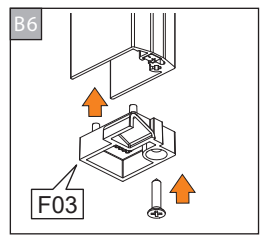
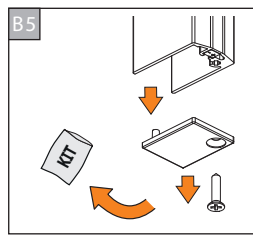
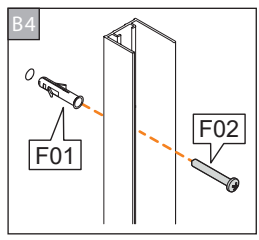
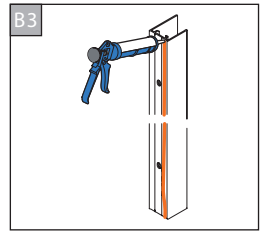
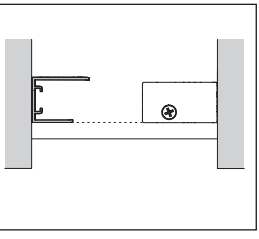
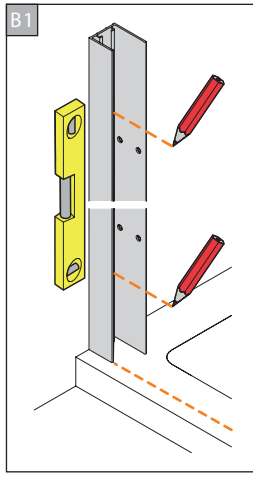
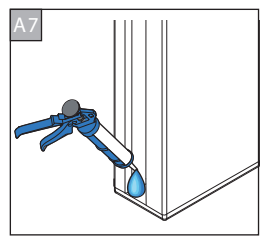
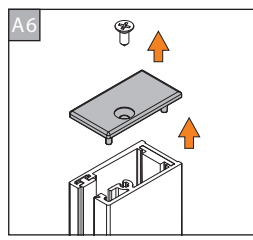
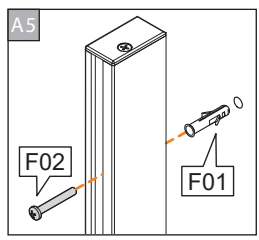
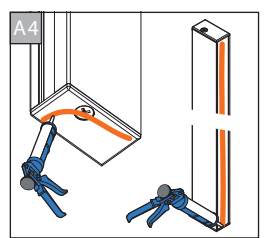
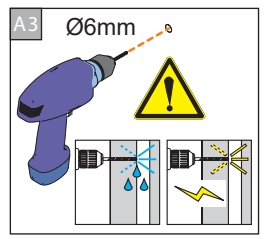
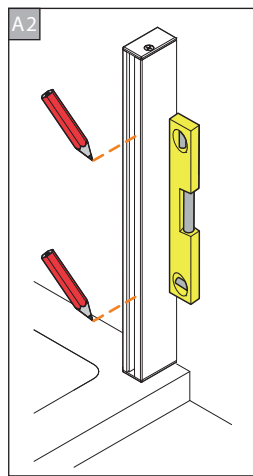
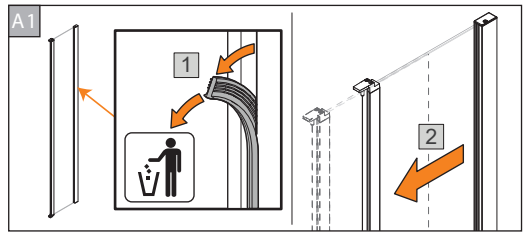
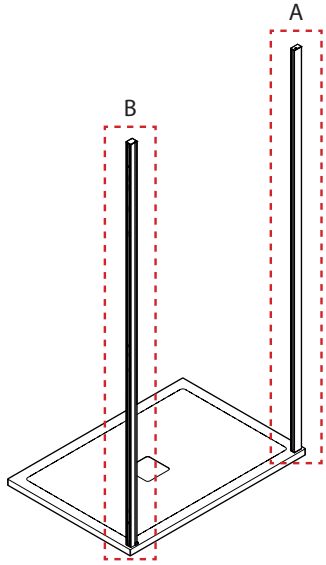



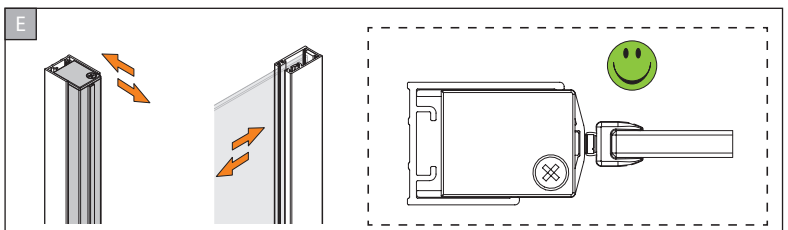
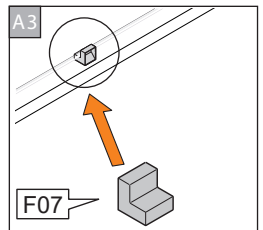
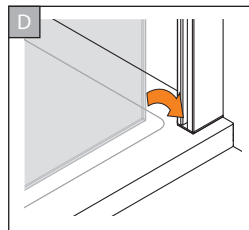
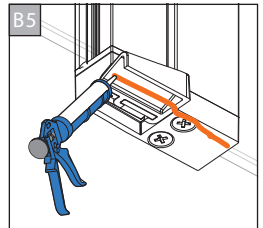
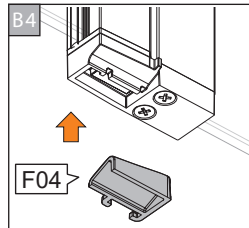
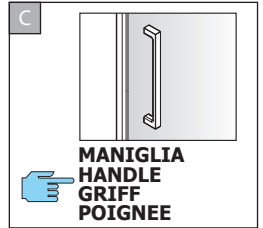
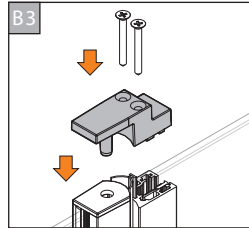
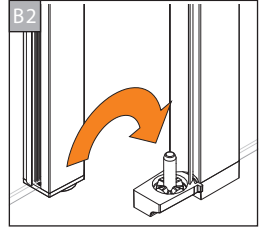
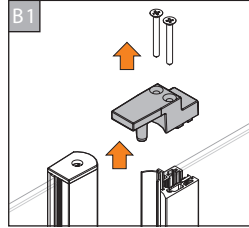
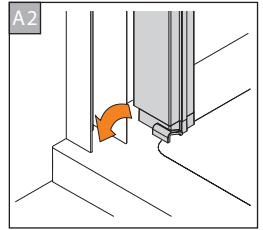
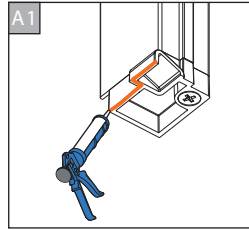
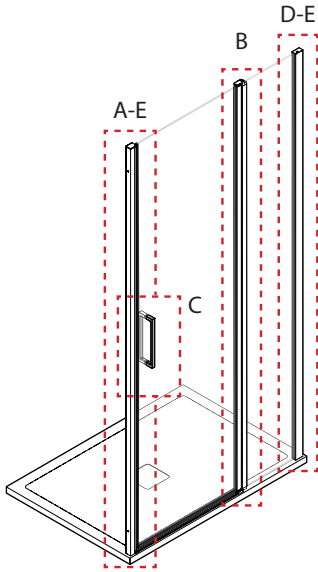

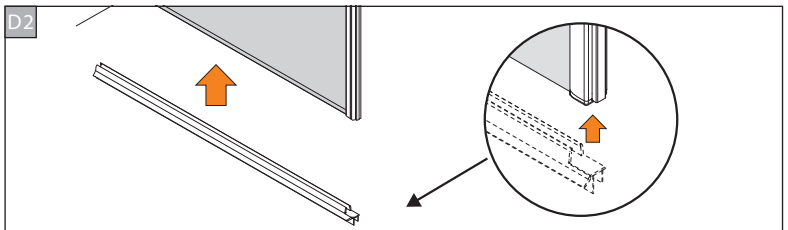
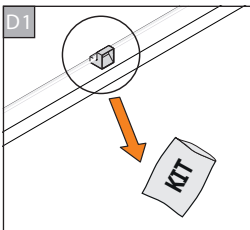
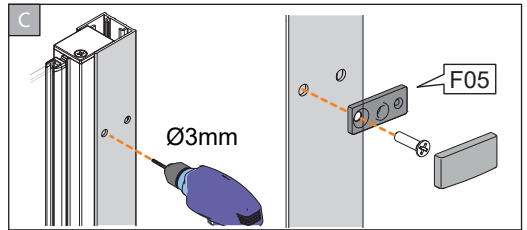
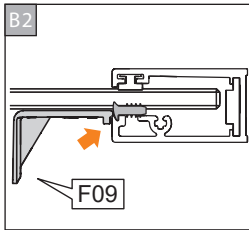
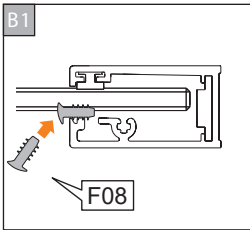
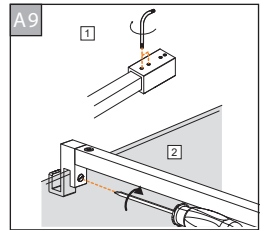
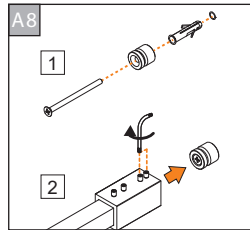
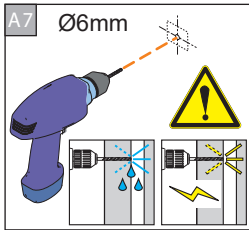
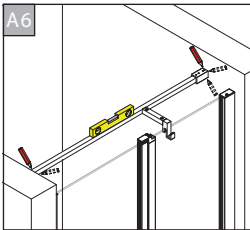
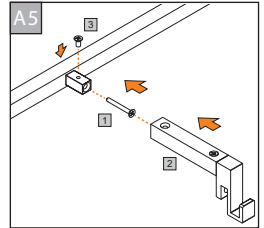
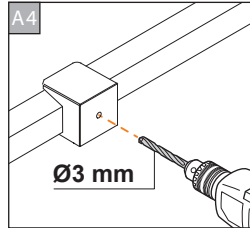
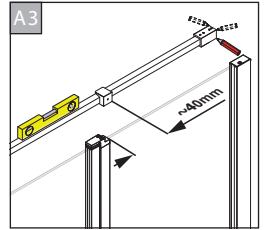
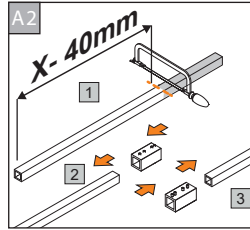
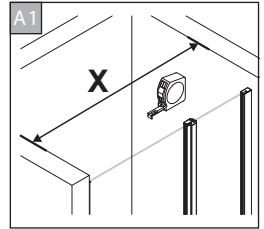
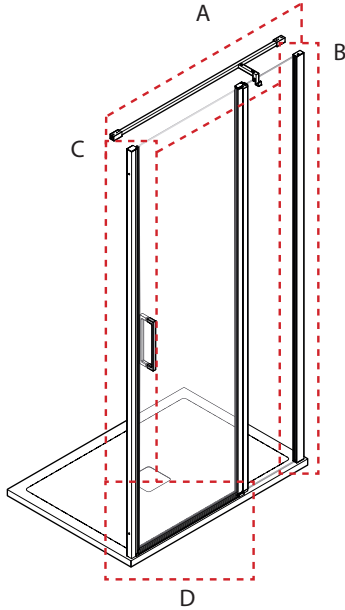

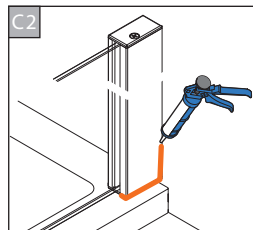
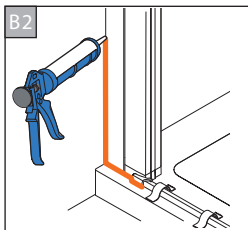
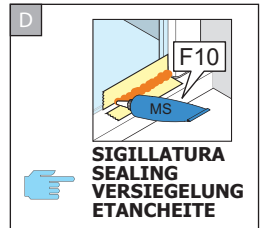
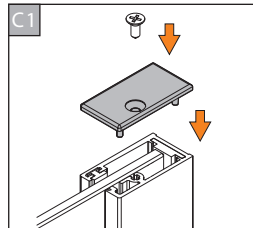
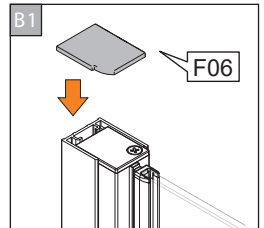
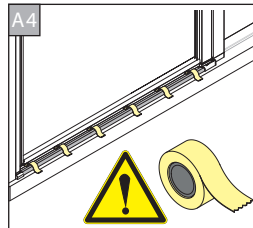
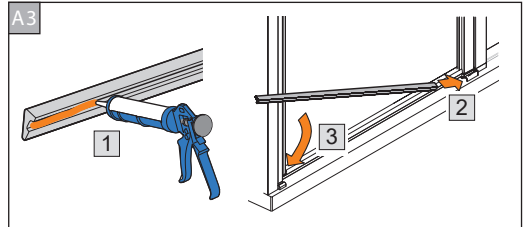
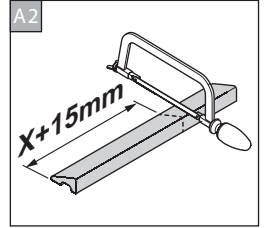
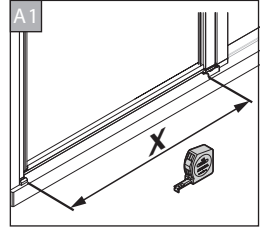
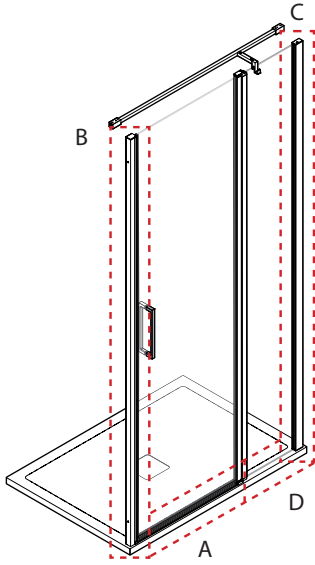

## FERRAMENTA / HARDWARE KIT / EISENWAREN-KIT / QUINCAILLERIE

INSTALLAZIONE DESTRA (la sinistra è speculare)

INSTALLATION RIGHT VERSION (left is specular)

MONTAGE DER RECHTSSAUSFÜHRUNG (link ist spiegelgleich)

INSTALLATION DROITE (la gauche est speculaire)

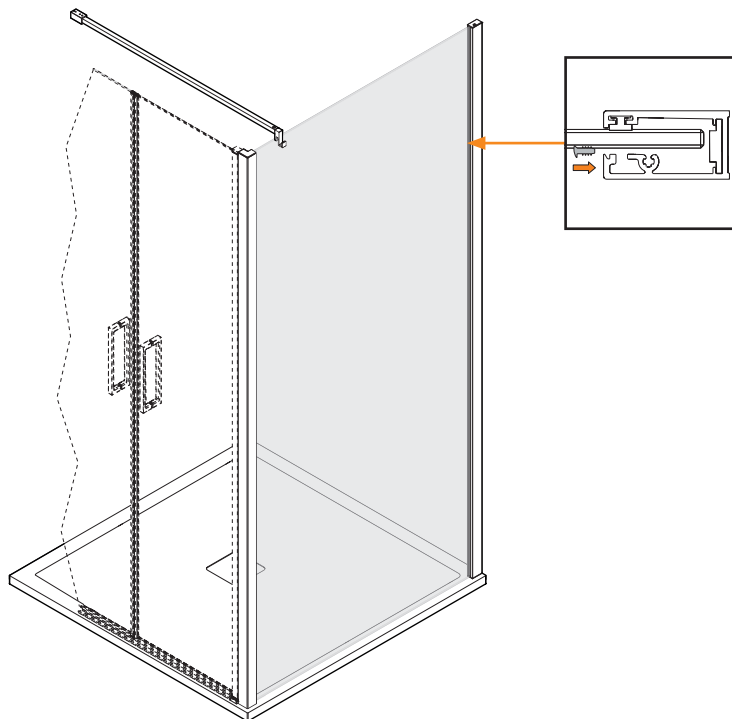

<p>F01</p> <p>N°2 Ø6x30</p>	<p>F02</p> <p>N°2 A 4,2x32 TCC</p>	<p>F03</p> <p>N°1</p>	<p>F04</p> <p>N°1</p>	<p>F05</p> <p>N°2</p>	<p>F06</p> <p>N°2 A 3,9x9,5 TCC</p>
<p>F07</p> <p>N°2</p>	<p>F08</p> <p>N°1</p>	<p>F09</p> <p>N°1</p>	<p>F10</p> <p>N°1</p>	<p>F11</p> <p>N°1</p>	

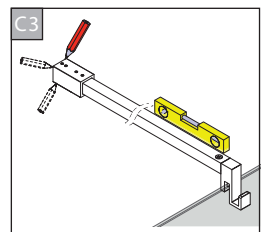
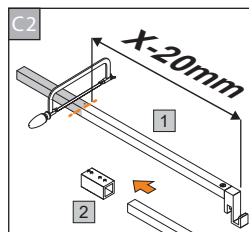
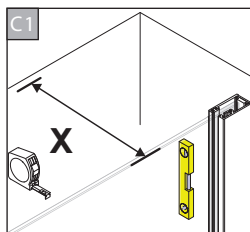
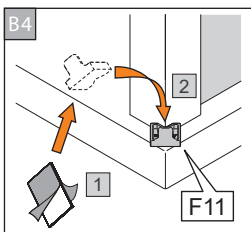
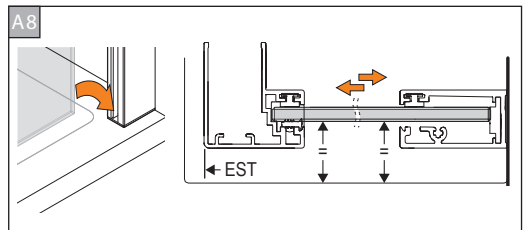
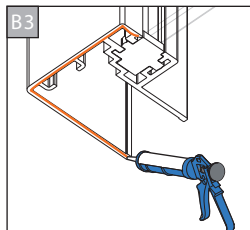
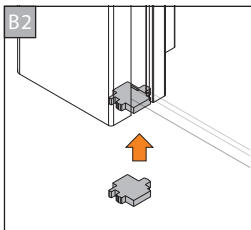
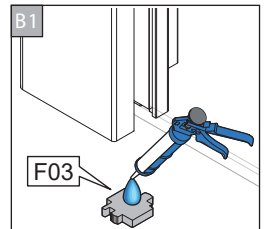
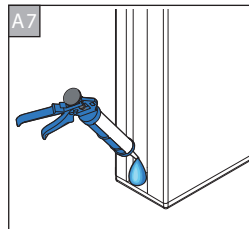
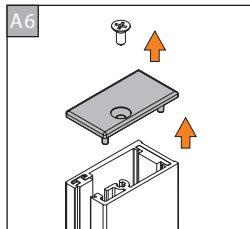
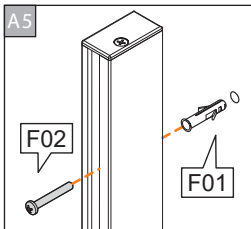
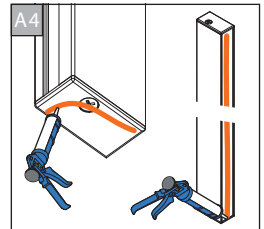
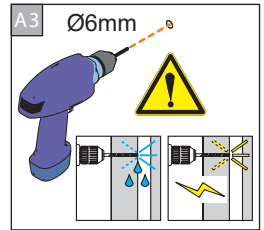
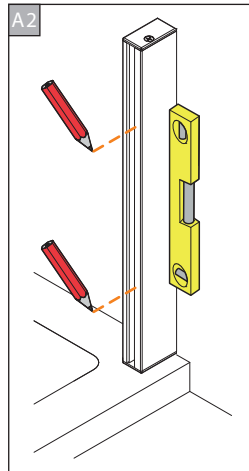
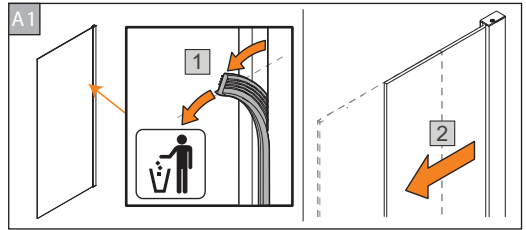
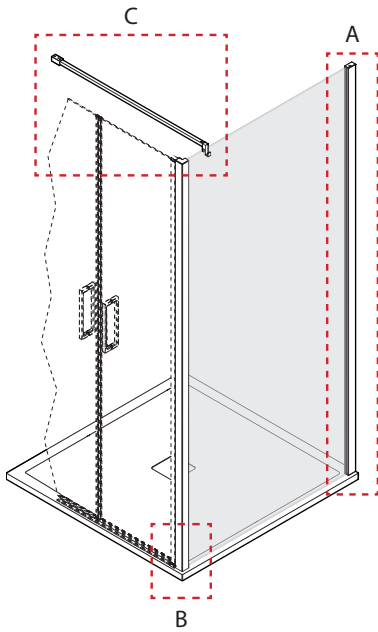

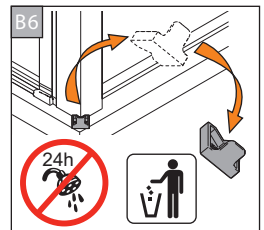
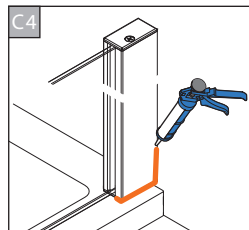
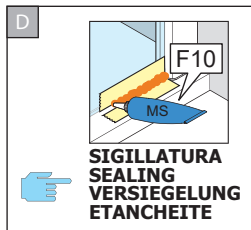
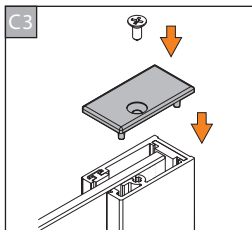
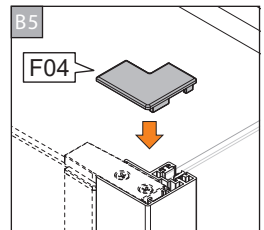
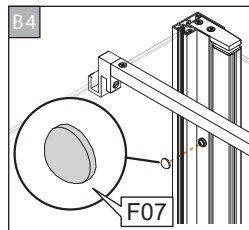
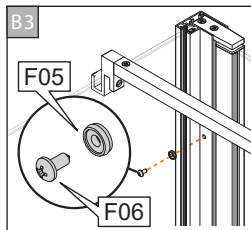
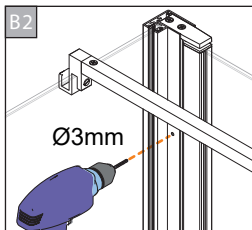
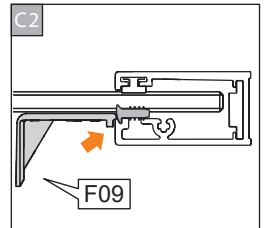
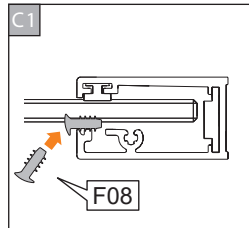
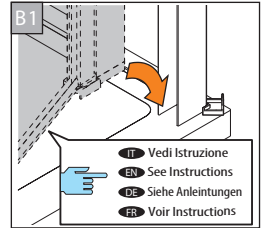
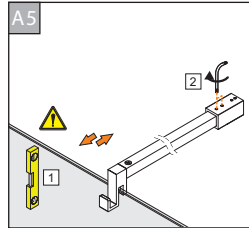
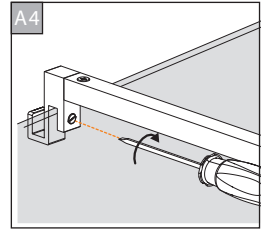
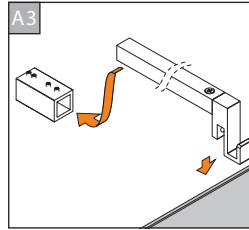
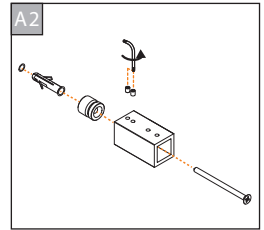
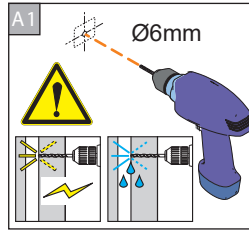
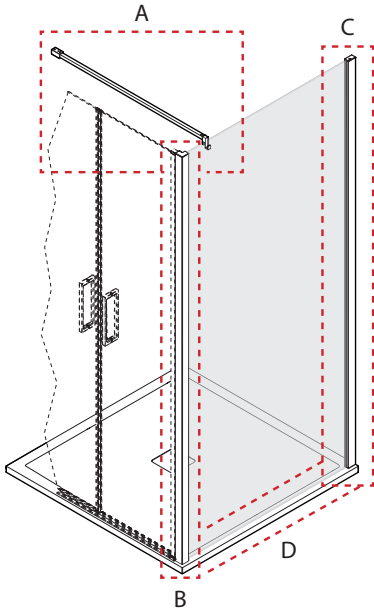





**Arblu srl**

Via Fossaluzza, 5 - 33074 Fontanafredda/PN - Italy  
tel +39 0434 5997 - fax +39 0434 599759 - info@arblu.it - assistenza@arblu.it  
Arblu Export - ph. +39 0434 599799 - export@arblu.it - service@arblu.it  
[www.arblu.com](http://www.arblu.com)

**09**

**DP000002**

Pareti doccia / Shower cabins / Duschkabine / Parois de douche:

**ICARO**

**PH**

**EN 14428**

**CA-IR-DA**