

Trattamento protezione vetro
Shower Glass Protect
Glasschutzbehandlung
Traitement protection verre

SGP

TIMELESS

GSS

ESTENSIBILITA':	EXTENSIBILITY:	DEHNBARKEIT:	EXTENSIBILITE:
<input type="checkbox"/> 77,5-79,5	<input type="checkbox"/> 82,5-84,5	<input type="checkbox"/> 87,5-89,5	<input type="checkbox"/> 92,5-94,5
<input type="checkbox"/> 102,5-104,5	<input type="checkbox"/> 107,5-109,5	<input type="checkbox"/> 112,5-114,5	<input type="checkbox"/> 117,5-119,5
<input type="checkbox"/> 127,5-129,5	<input type="checkbox"/> 132,5-134,5	<input type="checkbox"/> 137,5-139,5	<input type="checkbox"/> F.M. _____

PROFILO:	PROFILE:	PROFIL:	PROFIL:
<input type="checkbox"/> Argento Luc/Silver Brill/Silber Glanz/Argent brillant	<input type="checkbox"/> Alublack	<input type="checkbox"/> RAL opaco/mat/matt-lackiert/mat	
<input type="checkbox"/> Metal	<input type="checkbox"/> Metal Brushed		

VETRO:	GLASS:	GLAS:	VERRE:
<input type="checkbox"/> Trasparente/Transparent	<input type="checkbox"/> Extra light		
<input type="checkbox"/> Piumato/Piumate	<input type="checkbox"/> Vertical Plissé		
<input type="checkbox"/> Grigio Europa/Europe grey/Europa grau/gris europe	<input type="checkbox"/> Bronzo Glam/Bronze Glam		
<input type="checkbox"/> Specchiato/Mirror effect/Verspiegelter Glas/Effet miroir	<input type="checkbox"/> Satinato/Satin/Satinert/Satiné		
<input type="checkbox"/> Fascia/Band glass/Glas Band/Verre Bonde	<input type="checkbox"/> Serigrafato 3 fasce/Serigraphy 3-bang/Siebdruck 3-Bänder/3 bandes dépolies		

COD. RA900366



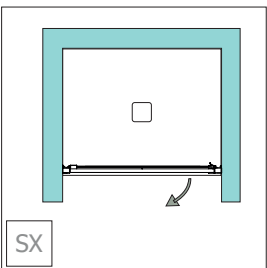

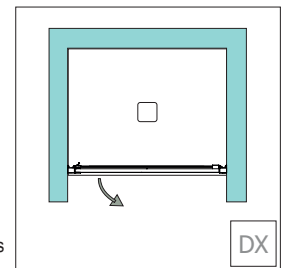

SF Sacchetto Ferramenta
Hardware pack
Rauchchrom
Sachet Quincailleries

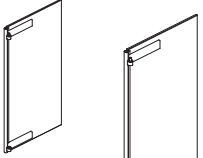
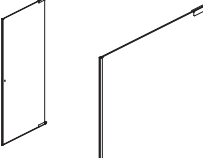
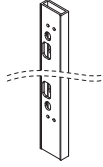

SX

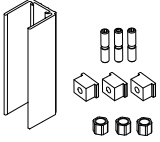

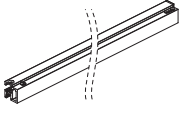
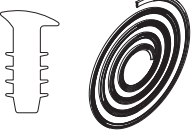
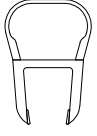
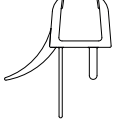
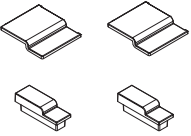
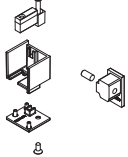
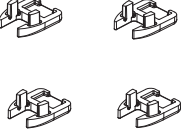

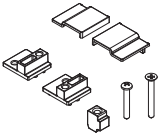
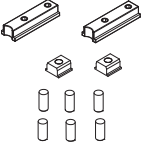
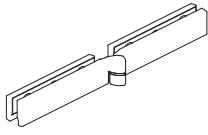
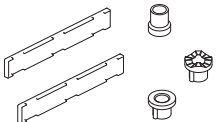
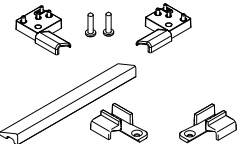

DX

<p>R01 COD. RA300387</p> <ul style="list-style-type: none"> VETRO FISSO FIXED SIDE FIXTEIL CÔTE FIXE 	<p>R02 COD. RA300389</p> <ul style="list-style-type: none"> ANTA BATTENTE WING DOOR SCHWENKTÜR PORTE BATTANTE 
<p>R03 COD. RA250525</p> <ul style="list-style-type: none"> PROFILO COMPENSATORE COMPENSATOR PROFILE AUSGLEICHSPROFIL PROFIL DE COMPENSATION 	<p>R04 COD. RA250530</p> <ul style="list-style-type: none"> KIT PROFILO COMPENSATORE COMPENSATOR PROFILE KIT AUSGLEICHSPROFIL PROFIL DE COMPENSATION 
<p>R05 COD. RA250526</p> <ul style="list-style-type: none"> KIT PROFILO COMPENSATORE COMPENSATOR PROFILE KIT AUSGLEICHSPROFIL PROFIL DE COMPENSATION 	<p>R06 COD. RA250527</p> <ul style="list-style-type: none"> PROFILO MONTANTE POST PROFILE FESTPROFIL PROFIL MONTANT 
<p>R07 COD. RA250523</p> <ul style="list-style-type: none"> KIT PROFILO CALAMITATO PROFILE WITH MAGNET KIT PROFIL MIT MAGNET KIT KIT PROFIL AIMANTE 	<p>R08 COD. RA250537</p> <ul style="list-style-type: none"> KIT PROFILO BASE SUPERIORE TOP BASE PROFILE KIT OBERES PROFIL KIT PROFIL BASE SUPERIEURE 
<p>R09 COD. RA200204</p> <ul style="list-style-type: none"> GUARNIZIONE TRASPARENTE (mt.2,1) TRANSPARENT GASKET (mt.2,1) TRANSPARENT DICHTUNG (mt.2,1) JOINT TRANSPARENT (mt.2,1) 	<p>R10 COD. RA200115</p> <ul style="list-style-type: none"> PROFILO PVC PROFILE PVC PROFIL AUS PVC PROFIL PVC 
<p>R11 COD. RA200177</p> <ul style="list-style-type: none"> PROFILO PVC PROFILE PVC PROFIL AUS PVC PROFIL PVC 	<p>R12 COD. RA400249</p> <ul style="list-style-type: none"> KIT TAPPI PROFILO COVER KIT STOPF KIT KIT CACHES PROFIL 
<p>R13 COD. RA400264</p> <ul style="list-style-type: none"> KIT TAPPI PROFILO COVER KIT STOPF KIT KIT CACHES PROFIL 	<p>R14 COD. RA400258</p> <ul style="list-style-type: none"> KIT TAPPI PROFILO COVER KIT STOPF KIT KIT CACHES PROFIL 
<p>R15 COD. RA400260</p> <ul style="list-style-type: none"> KIT TAPPI PROFILO COVER KIT STOPF KIT KIT CACHES PROFIL 	<p>R16 COD. RA400257</p> <ul style="list-style-type: none"> KIT TAPPI PROFILO COVER KIT STOPF KIT KIT CACHES PROFIL 
<p>R17 COD. RA900356</p> <ul style="list-style-type: none"> KIT RIFERIMENTO PERNO PIVOT-CENTRING-KIT PIVOT-ZENTRIERUNGSKIT KIT CENTRAGE PIVOT 	<p>R18 COD. RA900364</p> <ul style="list-style-type: none"> SET CERNIERA PLUS HINGE DOOR PLUS SET SCHARNIER DER TÜR PLUS SET SET CHARNIÈRE PORTE PLUS 
<p>R19 COD. RA400262</p> <ul style="list-style-type: none"> KIT COVER E BOCCOLE COVER AND BUSHING KIT SET-COVER UND ZYLINDRISCHER RING KIT CACHE ET DOUILLE CYLINDRIQUE 	<p>R20 COD. RA350130</p> <ul style="list-style-type: none"> KIT BORDINO SALVAGOCCIA DRIP CATCHER EDGE KIT TROPFENFÄNGER PROFIL KIT BAGUETTE D'ETANCHEITE 

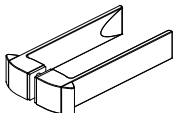
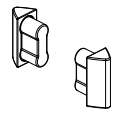
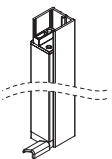

Specificare sempre l'estensibilità, la finitura del profilo, del vetro ed il verso della parete doccia
 Please specify always extensibility, profile colour, glass type and opening version of the shower cubicle (R or L)
 Verstellbereich, Profilfarbe, Glasvariante und Anschlag der Duschkabine (RE o. LI) immer angeben
 Toujours spécifier l'extensibilité, la finition du profil, la finition du verre et la version de la paroi de douche (droite ou gauche)

R21 COD. RA100038 (IT) SET MANIGLIA N (EN) HANDLES SET N (DE) HANDGRIFF SET N (FR) KIT POIGNÉE N		R22 COD. RA400263 (IT) KIT COVER MANIGLIA (EN) HANDLE-COVER-KIT (DE) GRIFF-ABDECKUNG-SET (FR) KIT CACHE POIGNEE	
R23 COD. RA250541 (IT) KIT PROFILI A MURO (EN) CLOSING SIDE PROFILES KIT (DE) ANSCHLAGSPROFIL-SET (FR) KIT PROFILS COTE DE FERMETURE	R05 R06 		

R24 COD. RA900359 (IT) KIT FERRAMENTA (EN) HARDWARE KIT (DE) EISENWAREN-KIT (FR) KIT QUINCAILLERIE			
 n°04 pz	(IT) TASSELLO Ø 6mm (EN) RAWPLUG Ø 6mm (DE) DÜBEL Ø 6mm (FR) BLOQUER Ø 6mm	 n°04 pz	(IT) VITE 4,2X32 TCC (EN) SCREW 4,2X32 TCC (DE) SCHRAUBE 4,2X32 TCC (FR) VIS 4,2X32 TCC
 n°12 pz	(IT) VITE TPSEI M6X14 (EN) SCREW TPSEI M6X14 (DE) SCHRAUBE TPSEI M6X14 (FR) VIS TPSEI M6X14	 n°02 pz	(IT) VITE TCEI M4X12 (EN) SCREW TCEI M4X12 (DE) SCHRAUBE TCEI M4X12 (FR) VIS TCEI M4X12



Specificare sempre l'estensibilità, la finitura del profilo, del vetro ed il verso della parete doccia
 Please specify always extensibility, profile colour, glass type and opening version of the shower cubicle (R or L)
 Verstellbereich, Profilfarbe, Glasvariante und Anschlag der Duschkabine (RE o. LI) immer angeben
 Toujours spécifier l'extensibilité, la finition du profil, la finition du verre et la version de la paroi de douche (droite ou gauche)