

Trattamento protezione vetro
Shower Glass Protect
Glasschutzbehandlung
Traitement protection verre



ESTENSIBILITA':	EXTENSIBILITY:	DEHNBARKEIT:	EXTENSIBILITE:
<input type="checkbox"/> 67,5-68,5	<input type="checkbox"/> 72,5-73,5	<input type="checkbox"/> 77,5-78,5	<input type="checkbox"/> 82,5-83,5
<input type="checkbox"/> F.M.			<input type="checkbox"/> 87,5-88,5





PROFILO:	PROFILE:	PROFIL:	PROFIL:
<input type="checkbox"/> Argento Luc/Silver Brill/Silber Glanz/Argent brillant	<input type="checkbox"/> Alublack	<input type="checkbox"/> RAL opaco/mat/matt-lackiert/mat	
<input type="checkbox"/> Metal	<input type="checkbox"/> Metal Brushed		

VETRO:	GLASS:	GLAS:	VERRE:
<input type="checkbox"/> Trasparente/Transparent	<input type="checkbox"/> Extra light		
<input type="checkbox"/> Piumato/Piumate	<input type="checkbox"/> Vertical Plissé		
<input type="checkbox"/> Grigio Europa/Europe grey/Europa grau/gris europe	<input type="checkbox"/> Bronzo Glam/Bronze Glam		
<input type="checkbox"/> Specchiato/Mirror effect/Verspiegelter Glas/Effet miroir	<input type="checkbox"/> Satinato/Satin/Satinert/Satiné		
<input type="checkbox"/> Fascia/Band glass/Glas Band/Verre Bonde	<input type="checkbox"/> Serigrafato 3 fasce/Serigraphy 3-bang/Siebdruck 3-Bänder/3 bandes dépolies		

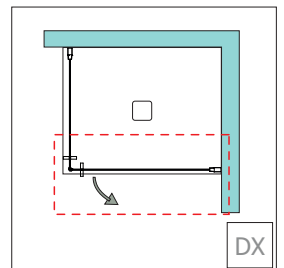
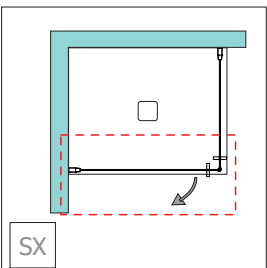
COD. RA900360

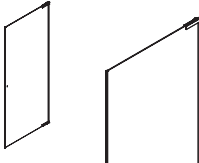
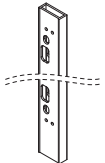
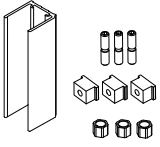
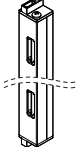
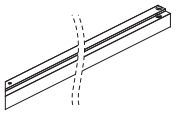
SF Sacchetto Ferramenta
Hardware pack
Rauchchrom
Sachet Quincailleries

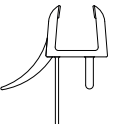
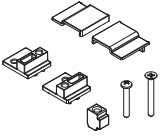
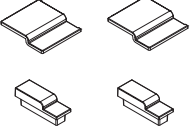
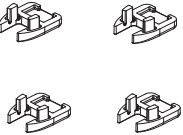
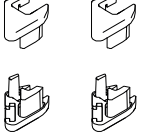

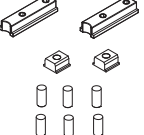
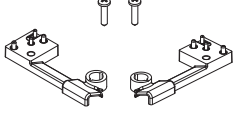
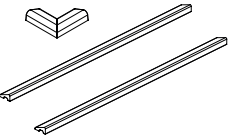
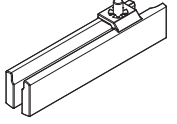
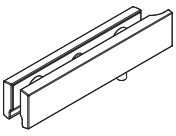
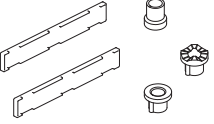



<p>R01 COD. RA300381</p> <ul style="list-style-type: none"> IT ANTA BATTENTE EN WING DOOR DE SCHWENKTÜR FR PORTE BATTANTE 		<p>R02 COD. RA250525</p> <ul style="list-style-type: none"> IT PROFILO COMPENSATORE EN COMPENSATOR PROFILE DE AUSGLEICHSPROFIL FR PROFIL DE COMPENSATION 	
<p>R03 COD. RA250526</p> <ul style="list-style-type: none"> IT KIT PROFILO COMPENSATORE EN COMPENSATOR PROFILE KIT DE AUSGLEICHSPROFIL FR PROFIL DE COMPENSATION 		<p>R04 COD. RA250527</p> <ul style="list-style-type: none"> IT PROFILO MONTANTE EN POST PROFILE DE FESTPROFIL FR PROFIL MONTANT 	
<p>R05 COD. RA250528</p> <ul style="list-style-type: none"> IT KIT PROFILO BASE SUPERIORE EN TOP BASE PROFILE KIT DE OBERES PROFIL FR KIT PROFIL BASE SUPERIEURE 		<p>R06 COD. RA250523</p> <ul style="list-style-type: none"> IT KIT PROFILO CALAMITATO EN PROFILE WITH MAGNET KIT DE PROFIL MIT MAGNET KIT FR KIT PROFIL AIMANTE 	
<p>R07 COD. RA250520</p> <ul style="list-style-type: none"> IT KIT PROFILI CALAMITATI EN PROFILES WITH MAGNET KIT DE PROFILES MIT MAGNET KIT FR KIT PROFILS AIMANTES 		<p>R08 COD. RA200177</p> <ul style="list-style-type: none"> IT PROFILO PVC EN PROFILE PVC DE PROFIL AUS PVC FR PROFIL PVC 	
<p>R09 COD. RA400257</p> <ul style="list-style-type: none"> IT KIT TAPPI PROFILO EN COVER KIT DE STOPF KIT FR KIT CACHES PROFIL 		<p>R10 COD. RA400249</p> <ul style="list-style-type: none"> IT KIT TAPPI PROFILO EN COVER KIT DE STOPF KIT FR KIT CACHES PROFIL 	
<p>R11 COD. RA400258</p> <ul style="list-style-type: none"> IT KIT TAPPI PROFILO EN COVER KIT DE STOPF KIT FR KIT CACHES PROFIL 		<p>R12 COD. RA400159</p> <ul style="list-style-type: none"> IT KIT TAPPI PROFILO EN COVER KIT DE STOPF KIT FR KIT CACHES PROFIL 	
<p>R13 COD. RA400259</p> <ul style="list-style-type: none"> IT KIT CURVA PROFILO EN CURVED PROFILE KIT DE GEBOGENES PROFIL KIT FR KIT COURBLE PROFIL 		<p>R14 COD. RA400260</p> <ul style="list-style-type: none"> IT KIT TAPPI PROFILO EN COVER KIT DE STOPF KIT FR KIT CACHES PROFIL 	
<p>R15 COD. RA900356</p> <ul style="list-style-type: none"> IT KIT RIFERIMENTO PERNO EN PIVOT-CENTRING-KIT DE PIVOT-ZENTRIERUNGSKIT FR KIT CENTRAGE PIVOT 		<p>R16 COD. RA400261</p> <ul style="list-style-type: none"> IT KIT BASETTE INFERIORI EN BOTTOM PLUGS KIT DE UNTERES STOPFEN-KIT FR KIT CACHES INFÉRIEURES 	
<p>R17 COD. RA350107</p> <ul style="list-style-type: none"> IT KIT BORDINO SALVAGOCCIA EN DRIP CATCHER EDGE KIT DE TROPFENFÄNGER PROFIL KIT FR KIT BAGUETTE D'ÉTANCHEITE 		<p>R18 COD. RA900357</p> <ul style="list-style-type: none"> IT KIT CERNIERA SUPERIORE EN UPPER HINGE KIT DE SET OBERE SCHARNIERE FR KIT CHARNIÈRE SUPÉRIEURE 	
<p>R19 COD. RA900358</p> <ul style="list-style-type: none"> IT KIT CERNIERA INFERIORE EN BOTTOM HINGE KIT DE SET UNTERE SCHARNIERE FR KIT CHARNIÈRE INFÉRIEURE 		<p>R20 COD. RA400262</p> <ul style="list-style-type: none"> IT KIT COVER E BOCCOLE EN COVER AND BUSHING KIT DE SET-COVER UND ZYLINDRISCHER RING FR KIT CACHE ET DOUILLE CYLINDRIQUE 	

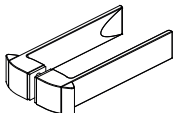
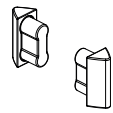
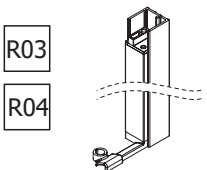
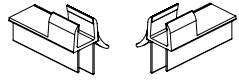

Specificare sempre l'estensibilità, la finitura del profilo, del vetro ed il verso della parete doccia
 Please specify always extensibility, profile colour, glass type and opening version of the shower cubicle (R or L)
 Verstellbereich, Profilfarbe, Glasvariante und Anschlag der Duschkabine (RE o. LI) immer angeben
 Toujours spécifier l'extensibilité, la finition du profil, la finition du verre et la version de la paroi de douche (droite ou gauche)

<p>R21 COD. RA100038</p> <ul style="list-style-type: none"> IT SET MANIGLIA N EN HANDLES SET N DE HANDGRIFF SET N FR KIT POIGNÉE N 		<p>R22 COD. RA400263</p> <ul style="list-style-type: none"> IT KIT COVER MANIGLIA EN HANDLE-COVER-KIT DE GRIFF-ABDECKUNG-SET FR KIT CACHE POIGNEE 	
<p>R23 COD. RA250538</p> <ul style="list-style-type: none"> IT KIT PROFILI A MURO EN WALL PROFILES KIT DE SET WANDPROFILE FR KIT PROFILÉS MURAUX 	<p>R03</p> <p>R04</p> 	<p>R24 COD. RA200284</p> <ul style="list-style-type: none"> IT PROFILO PVC EN PROFILE PVC DE PROFIL AUS PVC FR PROFIL PVC 	

<p>R25 COD. RA900359 IT KIT FERRAMENTA EN HARDWARE KIT DE EISENWAREN-KIT FR KIT QUINCAILLERIE</p>			
 <ul style="list-style-type: none"> IT TASSELLO Ø 6mm EN RAWPLUG Ø 6mm DE DÜBEL Ø 6mm FR BLOQUER Ø 6mm <p>n°04 pz</p>	 <ul style="list-style-type: none"> IT VITE 4,2X32 TCC EN SCREW 4,2X32 TCC DE SCHRAUBE 4,2X32 TCC FR VIS 4,2X32 TCC <p>n°04 pz</p>	 <ul style="list-style-type: none"> IT VITE TPSEI M6X14 EN SCREW TPSEI M6X14 DE SCHRAUBE TPSEI M6X14 FR VIS TPSEI M6X14 <p>n°12 pz</p>	 <ul style="list-style-type: none"> IT VITE TCEI M4X12 EN SCREW TCEI M4X12 DE SCHRAUBE TCEI M4X12 FR VIS TCEI M4X12 <p>n°02 pz</p>



Specificare sempre l'estensibilità, la finitura del profilo, del vetro ed il verso della parete doccia
 Please specify always extensibility, profile colour, glass type and opening version of the shower cubicle (R or L)
 Verstellbereich, Profilfarbe, Glasvariante und Anschlag der Duschkabine (RE o. LI) immer angeben
 Toujours spécifier l'extensibilité, la finition du profil, la finition du verre et la version de la paroi de douche (droite ou gauche)